



SP790

INSTRUCTION MANUAL

PROGRAMMABLE CONTROLLER

Contents (I : User's Guide)

1. Safety Guide	5
2. Control Keys and Display	7
3. Basic Flow Map	8
4. Setting Up Parameter in Each Group	9
4.1 NORMAL	9
4.1.1 FIX AUTO MODE	9
4.1.2 FIX MANUAL MODE	10
4.1.3 PROG MODE	11
4.2 H/C Operation	13
4.2.1 FIX AUTO MODE	13
4.2.2 FIX MANUAL MODE	14
4.2.3 PROG MODE	15
4.3 MAIN MENU 1	17
4.3.1 PROGRAM	17
4.3.2 RESERVE	24
4.3.3 GRAPH	25
4.3.4 USER SCREEN (US1, US2)	26
4.4 MAIN MENU 2	27
4.4.1 FUNCTION	27
4.4.2 PID SET	29
4.4.3 ALARM	33
4.4.4 AUTO TUNING	34
4.4.5 Auto/Manual MODE)	36
4.4.6 BIAS	37
4.3.4 USER SCREEN (US1, US2)	38
4.4.8 COMMUNICATION SET	39
4.5 SETUP MENU	40
4.5.1 INPUT SET	40
4.5.2 OUTPUT SET	42
4.5.3 RETRANSMISSION SET	45
4.5.4 INNER SIGNAL (IS) SET	46

4.5.5 ALARM SET	47
4.5.6 DO SET	49
4.5.7 BIAS SET	52
4.5.8 DI SET	54
4.5.9 PASSWORD	56
4.5.10 FILE EDIT	57
4.5.11 PTN SUB	58
4.5.12 SEG ALM	59
4.5.13 REPEAT	60
4.5.14 TIME SIGNAL	61
4.5.15 ON/OFF	62
4.6 TROUBLE SHOOTING	64
5. INSTALLATION	65
5.1 EXTERNAL DIMENSION & PANEL CUTTING SIZE	65
5.2 MOUNT INSTALLATION	66
5.3 Power Cable Specification	67
5.4 Terminal Specification	67
5.5 Terminal Arrangement and External Wiring	68
5.6 Grounding and Power Cable Connection	69
5.7 Analog Input Connection	69
5.8 Analog Output Connection	70
5.9 External Contact Output Connection (RELAY)	71
5.10 External Contact Output Connection (DO)	71
5.11 External Contact Input Connection(DI)	71
5.12 Use an Auxiliary Relay	72

Table 1 : Type of Input Sensor	41
Table 2 : Alarm Type	48
Table 1 : DI Operation	55
(Figure1 : Example of SSP START	20
(Figure2 : Example of S.PV START ①)	20
(Figure2 : Example of S.PV START ②)	21
(Figure4 : Example of S.PV START ③)	21
(Figure5 : Example of S.PV START ④)	21
(Figure6 : Example of S.PV START ⑤)	22
(Figure7 : Example of T.PV START)	22
(Figure8 : WAIT Op.- Example of Wait Function Release Within WTM)	23
(Figure9 : WAIT Op.- Example of PV can't enter the wait zone within WTM) ...	23
(Figure10 : FUZZY Funtion)	28
(Figure11 : Example of SLOPE SET (TMU : HH.MM)	28
(Figure12 : PID GROUP)	29
(Figure13 : Example of HEAT=PID, COOL=PID	30
(Figure14 : Example of HEAT=ON/OFF, COOL=PID)	30
(Figure15 : Example of HEAT=PID, COOL=ON/OFF)	31
(Figure16 : ON/OFF)	31
(Figure17 : ZONE PID AUTO TUNING)	35
(Figure18 : SEG PID AUTO TUNING)	35
(Figure19 : Example of CONTROL OUTPUT when CT=10 sec.)	42
(Figure20 : AT GAIN)	42
(Figure21 : Example of INNER SIGNAL ZONE)	46
(Figure22 : ALARM Operation)	48
(Figure23 : Example of UP, SOAK, DOWN, HOLD OUTPUT)	50
(Figure24 : Example of UP,DOWN OUTPUT when changing SP on FIX Mode)--	50
(Figure25 : Example of PIECE BIAS Formula)	52
(Figure26 : Example of ON/OFF MODE)	63

Contents (II : Communication User's Guide)

1. Communication Overview	73
2. Wiring for Communication	74
2.1 RS485 Interface Connection with SP790	74
3. Communication Command	75
3.1 COMMAND Configuration	75
3.2 COMMAND TYPE	76
3.3 Error Response	76
3.4 RSD COMMAND	77
3.5 RRD COMMAND	78
3.6 WSD COMMAND	79
3.7 WRD COMMAND	80
3.8 STD COMMAND	81
3.9 CLD COMMAND	82
4. MODBUS Protocol	83
4.1 Function Code	84
5. SYNC COMMUNICATION	88
5.1 SYNC-Master	88
5.1 SYNC-Slave	88
6. BROADCAST MODE	89
7. PROGRAM PATTERN SET	90
7.1 PROGRAM	90
7.2 PATTERN READING	91
7.3 PATTERN WRITING	91
7.4 PATTERN COPY/DELETE & SEGMENT INSERT/DELETE	92
ENCLOSURE. D-Register	93

1. Safety Guide

The following safety symbols are used in this manual.

- (A) If this symbol is marked on the product, the operator must investigate the explanation given in this manual to protect injury or death to personnel or damage to instrument.

CAUTION (1) For Production : It should be marked when operator must refer the explanation in the manual to avoid loss of life or damage to instrument.
(2) For Instruction Manual : It marks to avoid operator's loss of life and injury that may result comes from Electric Shock.

- (B) Protective Ground Terminal



It marks the terminal must be connected to Ground prior to operating the equipment.

- (C) It marks additional Information on the operation and features of the product.



- (D) It marks for further information on the current topic and pages.



Precautions on this instruction Manual

- (1) This Manual should be passed on the end User and keep a suitable place for operator to study and check the function of the product.
- (2) Operator should carefully study, understand how to operate this product before.
- (3) This manual is describing the functions of the product. We, Samwontech, does not warrant that the functions will suit a particular purpose.
- (4) Under absolutely no circumstance may the contents of this manual in part or in whole be transcribed or copied without permission.
- (5) All contents of this manual has been made to ensure accuracy in the preparation. However, should any errors or omissions come to the attention of the user, feel free to contact our sales representatives or our sales office.



Regarding Safety and Unauthorized Modification

- (1) In order to protect this product and the system controlled by it against damage and ensure its safe use, make certain that all of the safety instructions and precautions in this manual are strictly adhered to.
- (2) We, Samwontech, are not guarantee safety if the products are not handled according to this instruction manuals.
- (3) If separate protection or safety circuits are to be installed for this product or the system which is controlled by this product, ensure that such circuits are installed external to the product.
- (4) Don't try to make modifications or additions internal to the product. It may becomes electric shock, burn or out of order.
- (5) In case of replacement parts or consumables of the product, must call to our sales office.
- (6) Protect this product from moisture. It may becomes out of order.
- (7) Protect any kind of shock and vibration to the product. It may becomes product defects and out of order.



Regarding an exemption from responsibility

- (1) Samwontech co., Ltd does not make any warranties regarding the product except Warranty conditions those mentioned in this manual.
- (2) We assumes no liability to any party for any loss or damage, direct or indirect, caused by the use or any unpredictable defect of the product.



Regarding the production Quality Assurance.

- (1) The guaranteed period of the production quality assurance is one year after end user buy it and it will be free to fix defected product under regular usage described by this manual.
- (2) It will be charged to fix defected product after warranty period. This charge will announced by our actual cost to be calculated during the fixing time.
- (3) It will be charging even if within warranty period as following events.
 - (3.1) Defect by operator and user's default.(forget password, production initialize)
 - (3.2) Natural disaster,(fire, water flow etc)
 - (3.3) Additional shift after 1st installed.
 - (3.4) Improperly repaired, or altered, modified in anyway.
 - (3.5) Power failure in unstable power condition.
- (4) Feel free to contact our sales office whenever it need to make A/S.



Environmental precautions for installation.

- (1) Be sure to operate the controller installed on a panel to prevent electric shock.
- (2) To install the controller, do select a location where:
 - No one may accidentally touch terminal.
 - Mechanical vibrations are minimal.
 - No corrosive gas is present.
 - Temperature fluctuation is minimal.
 - Temperature can be maintained. (50 °C below / 10 °C over)
 - No direct heat radiation is present.
 - No magnetic disturbances are caused.
 - No water is splashed.
 - No flammable materials are around.
 - No wind blows. (prevent Dust with salt)
 - No ultraviolet rays are present.
 - Pollution Degree2
 - Installation Category II
 - Do not block openings
 - If the equipment is used in a manner not specified by the manufacturer, the protection provided by the equipment may be impaired.
 - A switch or circuit-breaker acting as the disconnect device shall be included in the application or the building installation.



Precautions of Controller Mounting.

- Keep the input circuit wiring as far as possible away from power and ground circuit.
- Keep the controllers in 10°C ~ 50°C/ 20 % ~ 90 % RH,
Warming up needed to use controller when temperature is below 10°C in advance.
- Do not mount front panel facing downward.
- To prevent electric shock, be sure to turn off and the source circuit breaker before wiring.
- The power consumptions are 100~240VAC, 50/60Hz, 15VAmax and operate without power switching in advance.
- No work in wet hands. (it caused electric shock)
- Follow operation by precaution in the manual to avoid fire, electric shock, loss of life etc.
- Requested to follow mounting and operation methods just indicated in this manual
- Refer the way of grounding connection, however, keep away for grounding to Gas pipe, water pipe, lightning rod etc.
- Be sure not to power connection before finishing of wiring between each contact point.
- Not close and wrapping the heat hole in back case of controller.

2. Control Keys and Display

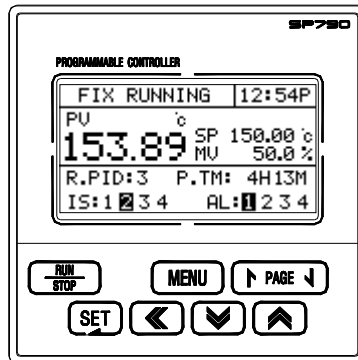

⊙ Control Keys

KEY	DESCRIPTION
	Run / Stop controller (Pressing the key at least 3 sec.)
	Switching between running and main menu page Change the up level page on the parameter setting page
	Switches to next page on the same level
	Switches to previous page on the same level
	Change to page on the menu Switching between parameters or registering parameter settings
	Move left / right on the parameter setting page Shifting position to modify value
	Decrease the value of parameters Change to other available items Move between GROUP
	Increase the value of parameters Change to other available items Move between GROUP

3. Basic Flow Map

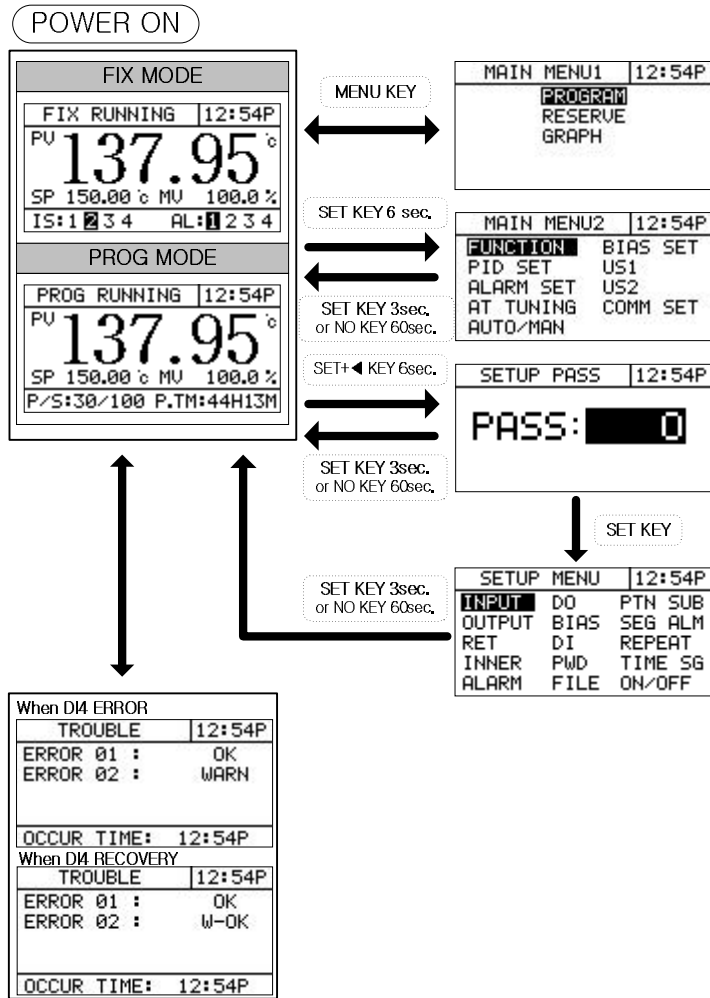



4. Setting Up Parameter in Each Group

4.1 NORMAL Operation

4.1.1 FIX AUTO MODE

<table border="1"> <tr><td>FIX STOP</td><td>12:54P</td></tr> <tr><td>PV</td><td>137.95 °C</td></tr> <tr><td>SP</td><td>150.00 °C</td></tr> <tr><td colspan="2">READY</td></tr> </table>	FIX STOP	12:54P	PV	137.95 °C	SP	150.00 °C	READY		<p>FIX Mode is controlling Temperature & Humidity with fixed SP. FIX STOP : Stop state SP : Set point (Setting by "SET" key) READY : Ready to running Start running by "RUN/STOP" key</p>								
FIX STOP	12:54P																
PV	137.95 °C																
SP	150.00 °C																
READY																	
<table border="1"> <tr><td>FIX RUNNING</td><td>12:54P</td></tr> <tr><td>PV</td><td>137.95 °C</td></tr> <tr><td>SP</td><td>150.00 °C</td></tr> <tr><td>MU</td><td>100.0 %</td></tr> <tr><td>IS:1</td><td>2 3 4</td></tr> <tr><td>AL:</td><td>2 3 4</td></tr> </table>	FIX RUNNING	12:54P	PV	137.95 °C	SP	150.00 °C	MU	100.0 %	IS:1	2 3 4	AL:	2 3 4	<p>FIX running 1st screen PV : Process value of temperature FIX RUNNING : Fix running state IS : State of Inner Signal AL : State of Alarm Signal</p>				
FIX RUNNING	12:54P																
PV	137.95 °C																
SP	150.00 °C																
MU	100.0 %																
IS:1	2 3 4																
AL:	2 3 4																
<table border="1"> <tr><td>FIX RUNNING</td><td>12:54P</td></tr> <tr><td>PV</td><td>153.89 °C</td></tr> <tr><td>SP</td><td>150.00 °C</td></tr> <tr><td>MU</td><td>50.0 %</td></tr> <tr><td>R.PID:</td><td>3</td></tr> <tr><td>P.TM:</td><td>4H13M</td></tr> <tr><td>IS:1</td><td>2 3 4</td></tr> <tr><td>AL:</td><td>2 3 4</td></tr> </table>	FIX RUNNING	12:54P	PV	153.89 °C	SP	150.00 °C	MU	50.0 %	R.PID:	3	P.TM:	4H13M	IS:1	2 3 4	AL:	2 3 4	<p>FIX running 2nd screen MV : State of Output R.PID(RUN PID NUMBER) : Running PID Number P.TM(PROCESS TIME) : Running Time</p>
FIX RUNNING	12:54P																
PV	153.89 °C																
SP	150.00 °C																
MU	50.0 %																
R.PID:	3																
P.TM:	4H13M																
IS:1	2 3 4																
AL:	2 3 4																
<table border="1"> <tr><td>FIX STOP</td><td>12:54P</td></tr> <tr><td>PV</td><td>137.95 °C</td></tr> <tr><td>SP</td><td>150.00 °C</td></tr> <tr><td colspan="2">FIX END</td></tr> </table>	FIX STOP	12:54P	PV	137.95 °C	SP	150.00 °C	FIX END		<p>FIX END : End of FIX Operation</p>								
FIX STOP	12:54P																
PV	137.95 °C																
SP	150.00 °C																
FIX END																	
<table border="1"> <tr><td>AUTO TUNING</td><td>12:54P</td></tr> <tr><td>PV</td><td>137.95 °C</td></tr> <tr><td>SP</td><td>150.00 °C</td></tr> <tr><td>MU</td><td>100.0 %</td></tr> <tr><td>IS:1</td><td>2 3 4</td></tr> <tr><td>AL:</td><td>2 3 4</td></tr> </table>	AUTO TUNING	12:54P	PV	137.95 °C	SP	150.00 °C	MU	100.0 %	IS:1	2 3 4	AL:	2 3 4	<p>AUTO TUNING screen It is same as Operation screen</p>				
AUTO TUNING	12:54P																
PV	137.95 °C																
SP	150.00 °C																
MU	100.0 %																
IS:1	2 3 4																
AL:	2 3 4																

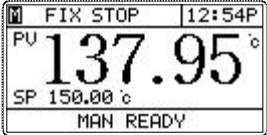
4.1.2 FIX MANUAL MODE

	FIX STOP : Stop state MAN READY : Ready to running Start running by "RUN/STOP" key for 3 sec.
	FIX running 1st screen (Standard Type) PV : Present Value of temperature IS : State of Inner Signal AL : State of Alarm Signal
	FIX END : End of FIX Operation

SYMBOL	PARAMETER	RANGE	DISPLAY	UNIT	DEFAULT	EDIT
SP	SET POINT	EU(0.0 ~ 100.0%)	Always	EU	EU(0.0%)	○
MV	MV	0.0 ~ 100.0%	MAN. Op.	%	×	○
R.PID	RUN PID NUMBER	1 ~ 4	Always	ABS	×	×
P.TM	PROCESS TIME	00H00M ~ 99H59M	Always	TIME	00H00M	×
IS	INNER SIGNAL	1 ~ 4 (Display State)	Always	ABS	×	×
AL	ALARM	1 ~ 4 (Display State)	Always	ABS	×	×

4.1.3 PROG MODE

<p>PROG STOP 12:54P PU 137.95 °C PTNO 30 SEGNO 100 READY</p>	<p>PROG Mode is controlling Temperature with programmed data. PTNO : Set pattern No.(Set with "SET" key) SEGNO : Start segment No. READY : Ready to running Start running by "RUN/STOP" key</p>
<p>PROG RUNNING 12:54P PU 137.95 °C SP 150.00 °C MU 100.0 % P/S:30/100 P.TM:44H13M</p>	<p>PROG running 1st screen PROG RUNNING : Prog running state P/S : Running PATTERN & SEGMENT P.TM(PROCESS TIME) : Running time</p>
<p>PROG RUNNING 12:54P PU °C 153.89 °C SP 150.00 °C MU 50.0 % R.PID:3 RM.TM: 4H13M TS:1 2 3 4 5 IS:1 2 3 4</p>	<p>PROG running 2nd screen R.PID : Running PID No.(Figure 12) RM.TM : Remaind running time TS : State of Time Signal IS : State of Inner Signal</p>
<p>PROG RUNNING 12:54P PU °C 153.89 °C SP 150.00 °C MU 50.0 % RUNNING PT/SG: 30/100 S.AL:1 2 3 4 AL:1 2 3 4</p>	<p>PROG running 3rd screen When HOLD ON, display held PT and SEG When HOLD OFF, display running state S.AL : State of Segment Alarm Signal AL : State of Alarm Signal</p>
<p>PROG RUNNING 12:54P PU °C 153.89 °C SP 150.00 °C MU 50.0 % HOLDING PT/SG: 30/100 S.AL:1 2 3 4 AL:1 2 3 4</p>	<p>PROG running 3rd screen (HOLDING screen) When HOLD ON, display held PT and SEG When HOLD OFF, display running state S.AL : State of Segment Alarm Signal AL : State of Alarm Signal</p>
<p>PROG RUNNING 12:54P HOLD: OFF STEP: OFF PTNO: 30 SEGNO:100 DOWN SOAK UP WAIT</p>	<p>PROG running 4th screen HOLD : "HOLD ON" or "HOLD OFF" with presents SP STEP : Stop to present segment then step to next segment DOWN : Going down zone SOAK : Gong stable zone UP : Going up zone WAIT : Going wait zone</p>
<p>PROG STOP 12:54P PU 137.95 °C PTNO 30 SEGNO 100 PATTERN END</p>	<p>PATTERN END : End of Pattern Operation</p>

AUTO TUNING 12:54P PU 137.95 °C SP 150.00 °C MV 100.0 % P/S:30/100 P.TM:44H13M	AUTO TUNING screen It is same as Operation screen
---	--

SYMBOL	PARAMETER	RANGE	DISPLAY	UNIT	DEFAULT	EDIT
SP	SET POINT	EUK0.0 ~ 100.0%)	Always	EU	×	X
MV	MV	0.0 ~ 100.0%	STD Type	%	0.0%	X
P/S	PATTERN / SEGMENT	1~30 / 1~100	Always	ABS	1 / 1	X
P.TM	PROCESS TIME	00H00M ~ 99H59M	Always	TIME	00H00M	X
R.PID	RUN PID NUMBER	1 ~ 4	Always	ABS	×	X
RM.TM	REMAIN TIME	00H00M~99H59M (TMU)	Always	TIME	×	X
TS	TIME SIGNAL	1 ~ 5 (Display State)	Always	ABS	×	X
IS	INNER SIGNAL	1 ~ 4 (Display State)	Always	ABS	×	X
RUNNING PT/SG	RUNNING PT/SG	1~30 / 1~100	Always	ABS	×	X
HOLDING PT/SG	HOLDING PT/SG	1~30 / 1~100	Always	ABS	×	X
AL	ALARM	1 ~ 4 (Display State)	Always	ABS	×	X
HOLD	HOLD	OFF, ON	Always	ABS	OFF	O
STEP	STEP	OFF, ON	Always	ABS	OFF	O
PTNO *1	PATTERN NUMBER	1 ~ 30	Always	ABS	×	X
PTNO *2	PATTERN NUMBER	0 ~ 30	Always	ABS	0	O
SEG NO	SEGMENT NUMBER	1~100	Always	ABS	×	X
DOWN, SOAK, UP, WAIT	DOWN, SOAK, UP, WAIT	Display State	Always	ABS	×	X

*1 : 4th Operation screen



*2 : STOP screen

4.2 H/C OPERATION SCREEN

4.2.1 FIX AUTO MODE

<table border="1"> <tr> <td>FIX STOP</td> <td>12:54P</td> </tr> <tr> <td>PV</td> <td>137.95 °C</td> </tr> <tr> <td>SP</td> <td>150.00 °C</td> </tr> <tr> <td colspan="2">READY</td> </tr> </table>	FIX STOP	12:54P	PV	137.95 °C	SP	150.00 °C	READY		<p>FIX Mode is controlling Temperature & Humidity with fixed SP. FIX STOP : Stop state SP : Set point (Setting by "SET" key) READY : Ready to running Start running by "RUN/STOP" key for 3 sec.</p>						
FIX STOP	12:54P														
PV	137.95 °C														
SP	150.00 °C														
READY															
<table border="1"> <tr> <td>FIX RUNNING</td> <td>12:54P</td> </tr> <tr> <td>PV</td> <td>137.95 °C</td> </tr> <tr> <td>SP</td> <td>150.00 °C</td> </tr> <tr> <td>HMU</td> <td>20.0%</td> </tr> <tr> <td>CMU</td> <td>20.0%</td> </tr> </table>	FIX RUNNING	12:54P	PV	137.95 °C	SP	150.00 °C	HMU	20.0%	CMU	20.0%	<p>FIX running 1st screen (H/C Type) PV : Process value of temperature FIX RUNNING : Fix running state HMU : State of HEAT Output CMU : State of COOL Output</p>				
FIX RUNNING	12:54P														
PV	137.95 °C														
SP	150.00 °C														
HMU	20.0%														
CMU	20.0%														
<table border="1"> <tr> <td>FIX RUNNING</td> <td>12:54P</td> </tr> <tr> <td>PV</td> <td>153.89 °C</td> </tr> <tr> <td>SP</td> <td>150.00 °C</td> </tr> <tr> <td>HMU</td> <td>20.0%</td> </tr> <tr> <td>CMU</td> <td>20.0%</td> </tr> <tr> <td>R.PID:3</td> <td>P.TM: 4H13M</td> </tr> <tr> <td>IS:1 2 3 4</td> <td>AL: 2 3 4</td> </tr> </table>	FIX RUNNING	12:54P	PV	153.89 °C	SP	150.00 °C	HMU	20.0%	CMU	20.0%	R.PID:3	P.TM: 4H13M	IS:1 2 3 4	AL: 2 3 4	<p>FIX running 2nd screen (H/C Type) R.PID(RUN PID NUMBER) : Running PID Number P.TM(PROCESS TIME) : Running Time IS : State of Inner Signal AL : State of Alarm Signal</p>
FIX RUNNING	12:54P														
PV	153.89 °C														
SP	150.00 °C														
HMU	20.0%														
CMU	20.0%														
R.PID:3	P.TM: 4H13M														
IS:1 2 3 4	AL: 2 3 4														
<table border="1"> <tr> <td>FIX STOP</td> <td>12:54P</td> </tr> <tr> <td>PV</td> <td>137.95 °C</td> </tr> <tr> <td>SP</td> <td>150.00 °C</td> </tr> <tr> <td colspan="2">FIX END</td> </tr> </table>	FIX STOP	12:54P	PV	137.95 °C	SP	150.00 °C	FIX END		<p>FIX END : End of Fix Operation</p>						
FIX STOP	12:54P														
PV	137.95 °C														
SP	150.00 °C														
FIX END															
<table border="1"> <tr> <td>AUTO TUNING</td> <td>12:54P</td> </tr> <tr> <td>PV</td> <td>137.95 °C</td> </tr> <tr> <td>SP</td> <td>150.00 °C</td> </tr> <tr> <td>HMU</td> <td>100.0%</td> </tr> <tr> <td>CMU</td> <td>0.0%</td> </tr> </table>	AUTO TUNING	12:54P	PV	137.95 °C	SP	150.00 °C	HMU	100.0%	CMU	0.0%	<p>AUTO TUNING screen. It is same as Operation screen</p>				
AUTO TUNING	12:54P														
PV	137.95 °C														
SP	150.00 °C														
HMU	100.0%														
CMU	0.0%														

4.2.2 FIX MANUAL MODE

 <p>FIX STOP 12:54P PU 137.95 °C SP 150.00 °C MAN READY</p>	<p>FIX STOP : Stop state SP : Set point (Setting by "SET" key) READY : Ready to running Start running by "RUN/STOP" key for 3 sec.</p>
 <p>FIX RUNNING 12:54P PU 137.95 °C SP 150.00 °C MU 50.0% HMV 50.0% CMV 50.0%</p>	<p>FIX running 1st screen (H/C Type) PV : Process value of temperature FIX RUNNING : Fix running state HMV : State of HEAT Output CMV : State of COOL Output</p>
 <p>FIX STOP 12:54P PU 137.95 °C SP 150.00 °C FIX END</p>	<p>FIX END : End of Fix Operation</p>

SYMBOL	PARAMETER	RANGE	DISPLAY	UNIT	DEFAULT	EDIT
SP	SET POINT	EU(0.0 ~ 100.0%)	Always	EU	EU(0.0%)	O
MV	MV	0.0 ~ 100.0%	MAN. Op.	%	×	O
HMV	HMV	0.0 ~ 100.0%	H/C Op.	%	0.0%	X
CMV	CMV	0.0 ~ 100.0%	H/C Op.	%	0.0%	X
R.PID	RUN PID NUMBER	1 ~ 4	Always	ABS	×	X
P.TM	PROCESS TIME	00H00M ~ 99H59M	Always	TIME	00H00M	X
IS	INNER SIGNAL	1 ~ 4	Always	ABS	×	X
AL	ALARM	1 ~ 4	Always	ABS	×	X

4.2.3 PROG MODE

<table border="1"> <tr><td>PROG STOP</td><td>12:54P</td></tr> <tr><td>PU</td><td>137.95 °C</td></tr> <tr><td>PTNO</td><td>30</td></tr> <tr><td>SEGNO</td><td>100</td></tr> <tr><td>READY</td><td></td></tr> </table>	PROG STOP	12:54P	PU	137.95 °C	PTNO	30	SEGNO	100	READY		<p>PROG Mode is controlling Temperature with programmed data. PTNO : Set pattern No.(Set with "SET" key) SEGNO : Start segment No. READY : Ready to running Start running by "RUN/STOP" key for 3 sec.</p>								
PROG STOP	12:54P																		
PU	137.95 °C																		
PTNO	30																		
SEGNO	100																		
READY																			
<table border="1"> <tr><td>PROG RUNNING</td><td>12:54P</td></tr> <tr><td>PU</td><td>137.95 °C</td></tr> <tr><td>SP</td><td>150.00 °C</td></tr> <tr><td>P/S</td><td>30/100</td></tr> <tr><td>HMU</td><td>50.0%</td></tr> <tr><td>CMU</td><td>50.0%</td></tr> </table>	PROG RUNNING	12:54P	PU	137.95 °C	SP	150.00 °C	P/S	30/100	HMU	50.0%	CMU	50.0%	<p>PROG running 1st screen PROG RUNNING : Program running state P/S : Running PATTERN & SEGMENT</p>						
PROG RUNNING	12:54P																		
PU	137.95 °C																		
SP	150.00 °C																		
P/S	30/100																		
HMU	50.0%																		
CMU	50.0%																		
<table border="1"> <tr><td>PROG RUNNING</td><td>12:54P</td></tr> <tr><td>PU</td><td>137.95 °C</td></tr> <tr><td>SP</td><td>150.00 °C</td></tr> <tr><td>P.TM</td><td>44H13M</td></tr> <tr><td>HMU</td><td>50.0%</td></tr> <tr><td>CMU</td><td>50.0%</td></tr> </table>	PROG RUNNING	12:54P	PU	137.95 °C	SP	150.00 °C	P.TM	44H13M	HMU	50.0%	CMU	50.0%	<p>PROG running 2nd screen PROG RUNNING : Prog running state P.TM(PROCESS TIME) : Running time</p>						
PROG RUNNING	12:54P																		
PU	137.95 °C																		
SP	150.00 °C																		
P.TM	44H13M																		
HMU	50.0%																		
CMU	50.0%																		
<table border="1"> <tr><td>PROG RUNNING</td><td>12:54P</td></tr> <tr><td>PU</td><td>153.89 °C</td></tr> <tr><td>SP</td><td>150.00 °C</td></tr> <tr><td>HMU</td><td>50.0%</td></tr> <tr><td>CMU</td><td>50.0%</td></tr> <tr><td>R.PID</td><td>3</td></tr> <tr><td>RM.TM</td><td>4H13M</td></tr> <tr><td>TS</td><td>1 2 3 4 5</td></tr> <tr><td>IS</td><td>1 2 3 4</td></tr> </table>	PROG RUNNING	12:54P	PU	153.89 °C	SP	150.00 °C	HMU	50.0%	CMU	50.0%	R.PID	3	RM.TM	4H13M	TS	1 2 3 4 5	IS	1 2 3 4	<p>PROG running 3rd screen R.PID : Running PID No.(Figure 12) RM.TM : Remaind running time TS : State of Time Signal IS : State of Inner Signal</p>
PROG RUNNING	12:54P																		
PU	153.89 °C																		
SP	150.00 °C																		
HMU	50.0%																		
CMU	50.0%																		
R.PID	3																		
RM.TM	4H13M																		
TS	1 2 3 4 5																		
IS	1 2 3 4																		
<table border="1"> <tr><td>PROG RUNNING</td><td>12:54P</td></tr> <tr><td>PU</td><td>153.89 °C</td></tr> <tr><td>SP</td><td>150.00 °C</td></tr> <tr><td>HMU</td><td>50.0%</td></tr> <tr><td>CMU</td><td>50.0%</td></tr> <tr><td>RUNNING PT/SG</td><td>30/100</td></tr> <tr><td>S.AL</td><td>1 2 3 4</td></tr> <tr><td>AL</td><td>1 2 3 4</td></tr> </table>	PROG RUNNING	12:54P	PU	153.89 °C	SP	150.00 °C	HMU	50.0%	CMU	50.0%	RUNNING PT/SG	30/100	S.AL	1 2 3 4	AL	1 2 3 4	<p>PROG running 4th screen When HOLD ON, display held PT and SEG When HOLD OFF, display running state S.AL : State of Segment Alarm Signal AL : State of Alarm Signal</p>		
PROG RUNNING	12:54P																		
PU	153.89 °C																		
SP	150.00 °C																		
HMU	50.0%																		
CMU	50.0%																		
RUNNING PT/SG	30/100																		
S.AL	1 2 3 4																		
AL	1 2 3 4																		
<table border="1"> <tr><td>PROG RUNNING</td><td>12:54P</td></tr> <tr><td>PU</td><td>153.89 °C</td></tr> <tr><td>SP</td><td>150.00 °C</td></tr> <tr><td>HMU</td><td>50.0%</td></tr> <tr><td>CMU</td><td>50.0%</td></tr> <tr><td>HOLDING PT/SG</td><td>30/100</td></tr> <tr><td>S.AL</td><td>1 2 3 4</td></tr> <tr><td>AL</td><td>1 2 3 4</td></tr> </table>	PROG RUNNING	12:54P	PU	153.89 °C	SP	150.00 °C	HMU	50.0%	CMU	50.0%	HOLDING PT/SG	30/100	S.AL	1 2 3 4	AL	1 2 3 4	<p>PROG running 4th screen (Holding) When HOLD ON, display held PT and SEG When HOLD OFF, display running state S.AL : State of Segment Alarm Signal AL : State of Alarm Signal</p>		
PROG RUNNING	12:54P																		
PU	153.89 °C																		
SP	150.00 °C																		
HMU	50.0%																		
CMU	50.0%																		
HOLDING PT/SG	30/100																		
S.AL	1 2 3 4																		
AL	1 2 3 4																		
<table border="1"> <tr><td>PROG RUNNING</td><td>12:54P</td></tr> <tr><td>HOLD</td><td>OFF</td></tr> <tr><td>STEP</td><td>OFF</td></tr> <tr><td>PTNO</td><td>30</td></tr> <tr><td>SEGNO</td><td>100</td></tr> <tr><td>DOWN</td><td>SOAK</td></tr> <tr><td>UP</td><td>WAIT</td></tr> </table>	PROG RUNNING	12:54P	HOLD	OFF	STEP	OFF	PTNO	30	SEGNO	100	DOWN	SOAK	UP	WAIT	<p>PROG running 5th screen HOLD : "HOLD ON" or "HOLD OFF" with presents SP STEP : Stop to present segment then step to next segment DOWN : Going down zone SOAK : Gong stable zone UP : Going up zone WAIT : Going wait zone</p>				
PROG RUNNING	12:54P																		
HOLD	OFF																		
STEP	OFF																		
PTNO	30																		
SEGNO	100																		
DOWN	SOAK																		
UP	WAIT																		

PROG STOP	12:54P	PATTERN END : End of Pattern Operation
PU	137.95 °C	
PTNO 30	SEGNO 100	
PATTERN END		

SYMBOL	PARAMETER	RANGE	DISPLAY	UNIT	DEFAULT	EDIT
SP	SET POINT	EU(0.0 ~ 100.0%)	Always	EU	×	X
MV	MV	0.0 ~ 100.0%	S ^{TD} type	%	0.0%	X
HMV	HMV	0.0 ~ 100.0%	H/C type	%	0.0%	X
CMV	CMV	0.0 ~ 100.0%	H/C type	%	0.0%	X
P/S	PATTERN / SEGMENT	1~30 / 1~100	Always	ABS	1 / 1	X
P.TM	PROCESS TIME	00H00M ~ 99H59M	Always	TIME	00H00M	X
R.PID	RUN PID NUMBER	1 ~ 4	Always	ABS	×	X
RM.TM	REMAIN TIME	00H00M~99H59M (TMU)	Always	TIME	×	X
TS	TIME SIGNAL	1 ~ 5 (Display State)	Always	ABS	×	X
IS	INNER SIGNAL	1 ~ 4 (Display State)	Always	ABS	×	X
RUNNING PT/SG	RUNNING PT/SG	1~30 / 1~100	Always	ABS	×	X
HOLDING PT/SG	HOLDING PT/SG	1~30 / 1~100	Always	ABS	×	X
S.AL	SEGMENT ALARM	1 ~ 4 (Display State)	H/C type	ABS	×	X
AL	ALARM	1 ~ 4 (Display State)	Always	ABS	×	X
HOLD	HOLD	OFF, ON	Always	ABS	OFF	○
STEP	STEP	OFF, ON	Always	ABS	OFF	○
PTNO *1	PATTERN NUMBER	1 ~ 30	Always	ABS	×	X
PTNO *2	PATTERN NUMBER	0 ~ 30	Always	ABS	0	○
SEG NO	SEGMENT NUMBER	1~100	Always	ABS	×	X
DOWN, SOAK, UP, WAIT	DOWN, SOAK, UP, WAIT	Display State	Always	ABS	×	X

*1 : Operation 4th screen

*2 : STOP screen

4.3 MAIN MENU 1

4.3.1 PROGRAM SETTING

<pre> MAIN MENU1 12:54P PROGRAM RESERVE GRAPH </pre>	<p>MAIN MENU 1 screen. This screen will be displayed by MENU KEY on Operation screen. And Operation screen will return by pushing MENU KEY again When setting US 1,2 on MAIN MENU 2 to "NONE", USER SCREEN will not be displayed. (For using US 1,2 screen, refer to the 4.3.4 USER SCREEN (US 1,2))</p>
<pre> PROGRAM 12:54P PATTERN WAIT </pre>	<p>PROGRAM SET screen to enter PATTERN SET. This screen will be displayed by SET KEY after selecting PROGRAM on MAIN MENU 1</p>
<pre> PATTERN SET 12:54P PT NO : 30 STC : S,PV SSP : 150.00 USED PT : 30/30 USED SEG : 300/300 </pre>	<p>PATTERN SET screen to edit program pattern will be displayed by SET KEY after selecting PATTERN on PROGRAM SET screen. PT NO : Number of PATTERN for set STC : Set START CODE SSP, S,PV, T,PV SSP : Set the value of START SET POINT (SSP) USED PT/SEG : Number of used PATTERN and SEGMENT</p>
<pre> SG SP TIME 12345 001 -50.00 -0.01 000000 002 -50.00 -0.01 000000 003 -50.00 -0.01 000000 004 -50.00 -0.01 000000 005 -50.00 -0.01 000000 </pre>	<p>This screen is to set the SET POINT, TIME, TIME SIGNAL (T) 1,2,3,4,5 of each SEGMENT. Screen to edit TIME SIGNAL (T) will be displayed by SET KEY after selecting TIME SG on SETUP MENU screen</p>
<pre> SG SP TIME 12345 096 -50.00 -0.01 000000 097 -50.00 -0.01 000000 098 -50.00 -0.01 000000 099 -50.00 -0.01 000000 100 -50.00 -0.01 000000 </pre>	<p>This screen is to set the SET POINT, TIME, TIME SIGNAL (T) 1,2,3,4,5 of each SEGMENT. Screen to edit TIME SIGNAL (T) will be displayed by SET KEY after selecting TIME SG on SETUP MENU screen</p>
<pre> ←:ESC ↓:DEL ▲:INS 001 -50.00 -0.01 000000 002 -50.00 -0.01 000000 003 -50.00 -0.01 000000 004 -50.00 -0.01 000000 005 -50.00 -0.01 000000 </pre>	<p>This screen to edit SEGMENT will be displayed by SET KEY under the cursor on the SEGMENT number (001,002, ..) in SEGMENT SET screen Each SEGMENT can be copied, inserted or deleted by using UP, DOWN KEY. SHIFT KEY makes this screen back to previous</p>

SYMBOL	PARAMETER	RANGE	DISPLAY	UNIT	DEFAULT	EDIT
PT NO	PATTERN NUMBER	1~30	Always	ABS	0	O
STC	START CODE	SSP, S.PV, T.PV	Always	ABS	S.PV	O
SSP	START SET POINT	EU(0.0 ~ 100.0%)	Always	EU	EU(0.0%)	O
UESD PT	USED PATTERN	0~30	Always	ABS	0	X
USED SEG	USED SEGMENT	0~300	Always	ABS	0	X
SG	SEGMENT NUMBER	001~100	Always	ABS	001	X
SP	SET POINT	EU(0.0 ~ 100.0%)	Always	EU	EU(0.0%)	O
TIME	TIME(HH,MM, MM,SS)	-0.01(OFF)~99.59(TMJ)	Always	TIME	-00.01(OFF)	O
1	TIME SIGNAL1	0~9	Always	ABS	0	O
2	TIME SIGNAL2	0~9	Always	ABS	0	O
3	TIME SIGNAL3	0~9	Always	ABS	0	O
4	TIME SIGNAL4	0~9	Always	ABS	0	O
5	TIME SIGNAL5	0~9	Always	ABS	0	O

<p>PROGRAM 12:54P PATTERN WAIT</p>	<p>PROGRAM SET screen to enter WAIT SET. This screen will be displayed by SET KEY after selecting PROGRAM on MAIN MENU 1</p>
<p>WAIT SET 12:54P WAIT ZONE: 0.0 °C WAIT TIME: 00.00 H.M</p>	<p>WAIT ZONE : Set the temperature during WAIT ZONE. When setting 0,0 to this parameter, WAIT operation will not work. WAIT TIME : Set the time for WAIT operation. When setting 00,00 to this parameter, WAIT state will keep going on until this time will be in WAIT ZONE.</p>

SYMBOL	PARAMETER	RANGE	DISPLAY	UNIT	DEFAULT	EDIT
WAIT ZONE	WAIT ZONE	EUS(0.0 ~ 100.0%)	Always	EUS	EUS(0.0%)	○
WAIT TIME	WAIT TIME	00,00 ~ 99,59 (T.M)	Always	TIME	00,00 H.M	○

※ START CODE (STC) Operation

- SSP START(STC = SSP)

When starting program run, Initial SP is beginning from SSP.
 SP will be getting to change from initial SP to SP1 (Target SP) of SEGMENT1 during SEGMENT TIME1 (TM1).

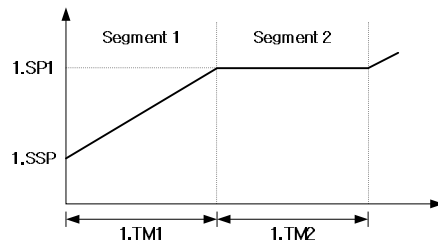

(Figure1 : Example of SSP START)

1) S,PV START(STC = S,PV)

When starting program run, Initial SP is beginning from PV (Present Value).
 SP will be getting to change from PV to Target SP of next SEGMENT, And its processing time can be variable depending on the calculated remaining time by referring to program pattern as of time passed to the first Target SP.

When using PV Start, the first SEGMENT for program running is the RAMP period SEGMENT that is preceding the first SOAK period.
 Followings explain how to operate depending on where the first SEGMENT.

① SEGMENT2 is the first SOAK period

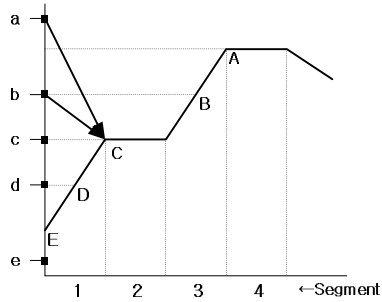

(Figure2 : Example of S,PV START ①)

PV when starting PROG RUN	Start Point of PROG RUN
a	C
b	C
c	C
d	D
e	E(SSP)

② SEGMENT3 is the first SOAK period

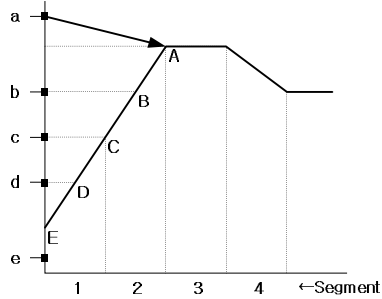

PV when starting PROG RUN	Start Point of PROG RUN
a	A
b	B
c	C
d	D
e	E(SSP)

(Figure3 : Example of S,PV START ②)

③ NO SOAK period

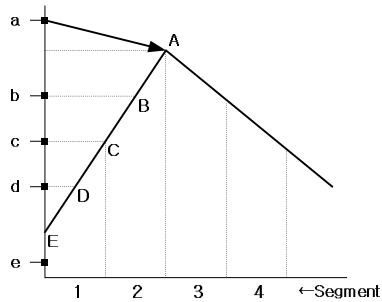

PV when starting PROG RUN	Start Point of PROG RUN
a	A
b	B
c	C
d	D
e	E(SSP)

(Figure4 : Example of S,PV START ③)

④ Only RAMP period (Ascending) without SOAK

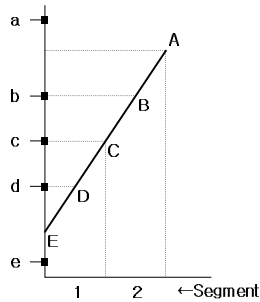

PV when starting PROG RUN	Start Point of PROG RUN
a	PROG RUN can not be started
b	B
c	C
d	D
e	E(SSP)

(Figure5 : Example of S,PV START ④)

⑤ 1SEGMENT SOAK

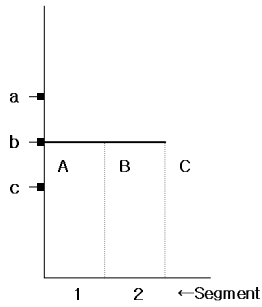

PV when starting PROG RUN	Start Point of PROG RUN
a	B
b	B
c	A(SSP)

(Figure6 : Example of S,PV START ⑤)

2) T,PV START

Priority when using T,PV is the time.
T,PV START operates according to a prefixed PROGRAM PATTERN from the PV regardless of slant,

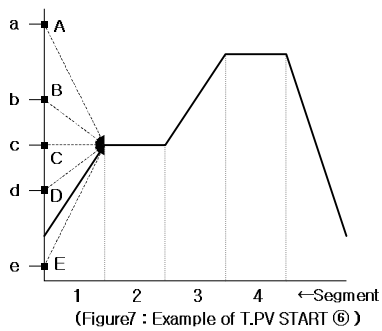

PV when starting PROG RUN	Start Point of PROG RUN
a	A
b	B
c	C
d	D
e	E

(Figure7 : Example of T,PV START ⑥)

※ WAIT Operation

The wait function holds off the transition of segment until deviation is cleared up. The use of this function is enabled by defining a wait zone that is a deviation range to determine the follow-up of PV data input, and a wait time, which is a period of waiting time until PV data enters the wait zone. When PV input enters the wait zone within the wait time, the operation shifts to the next. If not, the shift takes place as soon as the wait time is over, The WTM should be set for prevent to infinite waiting.

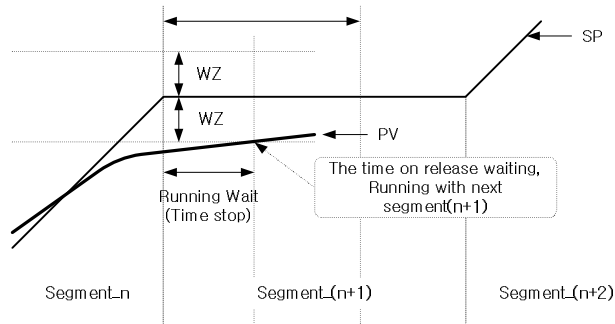

(Figure8 : WAIT - Ex. Wait Function Release Within WTM)

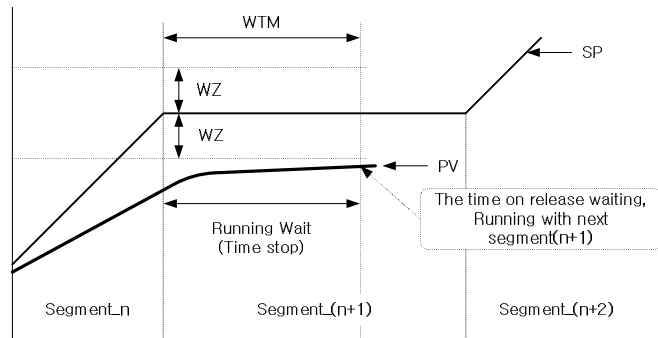

(Figure9 : WAIT - Ex. PV can't enter the wait zone within WTM)

4.3.2 RESERVE SET

	<p>MAIN MENU 1 screen to enter RESERVE SET This screen will be displayed by MENU KEY on Operation screen. And Operation screen will return by pushing MENU KEY again RESERVE SET screen will be displayed by SET KEY when cursor on RESERVE in MAIN MENU 1.</p>
	<p>NOW : Display present year, month, date and time which is set on SET DATE area RUN DATE : Set reserved starting year, month, date and time SET DATE : Set present year, month, date and time RESERVE : Use/Not use</p>

SYMBOL	PARAMETER	RANGE	DISPLAY	UNIT	DEFAULT	EDIT
Y	YEAR	0 ~ 99	Always	ABS	0	O (Except NOW DATE)
M	MONTH	1 ~ 12	Always	ABS	1	
D	DAY	1 ~ 31	Always	ABS	1	
H	HOUR	0 ~ 23	Always	ABS	0	
M	MINUTE	0 ~ 59	Always	ABS	0	
RESERVE	RESERVE SET	OFF, ON	Always	ABS	OFF	O

4.3.3 GRAPH SET

	<p>MAIN MENU 1 screen to enter GRAPH SET This screen will be displayed by MENU KEY on Operation screen, And Operation screen will return by pushing MENU KEY again GRAPH SET screen will be displayed by SET KEY when cursor on GRAPH in MAIN MENU 1.</p>
---	---

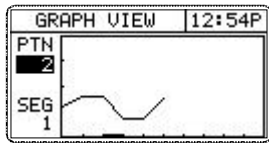
	<p>Display segment on pattern by graph PTN : Set the pattern No, for wished see SEG : Set the segment No, for display starting</p>
---	--

SYMBOL	PARAMETER	RANGE	DISPLAY	UNIT	DAFAULT	EDIT
PTN	PATTERN NUMBER	1 ~ 30	Always	ABS	1	O
SEG	SEGMENT NUMBER	1,11,21,31,41, 51,61,71,81,91	Always	ABS	Start SEG on Display	X

4.3.4 USER SCREEN (US1, US2)

<table border="1"> <tr> <td>MAIN MENU1</td> <td>12:54P</td> </tr> <tr> <td>PROGRAM</td> <td></td> </tr> <tr> <td>RESERVE</td> <td></td> </tr> <tr> <td>GRAPH</td> <td></td> </tr> <tr> <td>ALARM</td> <td></td> </tr> <tr> <td>FILE EDIT</td> <td></td> </tr> </table>	MAIN MENU1	12:54P	PROGRAM		RESERVE		GRAPH		ALARM		FILE EDIT		<p>MAIN MENU 1 screen. This screen can be displayed when set US 1, 2 of MAIN MENU 2. USER SCREEN is helpful function to display frequently used parameters of MAIN MENU 2 or SETUP MENU to MAIN MENU 1. Ex) When setting US1 = ALARM, US2 = FILE EDIT, MAIN MENU 1 will be shown as right screen.</p>
MAIN MENU1	12:54P												
PROGRAM													
RESERVE													
GRAPH													
ALARM													
FILE EDIT													

4.4 MAIN MENU 2

4.4.1 FUNCTION SET

<table border="1"> <tr> <td>MAIN MENU2</td> <td>12:54P</td> </tr> <tr> <td>FUNCTION</td> <td>BIAS SET</td> </tr> <tr> <td>PID SET</td> <td>US1</td> </tr> <tr> <td>ALARM SET</td> <td>US2</td> </tr> <tr> <td>AT TUNING</td> <td>COMM SET</td> </tr> <tr> <td>AUTO/MAN</td> <td></td> </tr> </table>	MAIN MENU2	12:54P	FUNCTION	BIAS SET	PID SET	US1	ALARM SET	US2	AT TUNING	COMM SET	AUTO/MAN		<p>MAIN MENU 2 screen This screen will be displayed by SET KEY on Operation screen for 6 sec. And Operation screen will return by pushing SET KEY again for 3 sec, or NO KEY input for 60 sec.</p>
MAIN MENU2	12:54P												
FUNCTION	BIAS SET												
PID SET	US1												
ALARM SET	US2												
AT TUNING	COMM SET												
AUTO/MAN													
<table border="1"> <tr> <td>FUNCTION1</td> <td>12:54P</td> </tr> <tr> <td>OPER MODE:</td> <td>PROG</td> </tr> <tr> <td>PWR MODE :</td> <td>STOP</td> </tr> <tr> <td>KEY LOCK :</td> <td>OFF</td> </tr> <tr> <td>BUZZER :</td> <td>OFF</td> </tr> <tr> <td>FUZZY :</td> <td>OFF</td> </tr> </table>	FUNCTION1	12:54P	OPER MODE:	PROG	PWR MODE :	STOP	KEY LOCK :	OFF	BUZZER :	OFF	FUZZY :	OFF	<p>OPER MODE : Selectable Operation mode of FIX / PROG PWR MODE : Selectable Operation mode after power failure that will be recognized over 3 sec, power failure, If power on within 3 sec, It is automatically running with HOT mode</p> <ul style="list-style-type: none"> ▶ STOP : After power failure, go to STOP state ▶ COLD : After power failure, go to RUN on fix running or go to SEG1 on program running, ▶ HOT : After power failure, running by previous data before power failure. <p>KEY LOCK : Set key in possible / impossible</p> <ul style="list-style-type: none"> ▶ ON : Lock(Key in impossible) ▶ OFF : Unlock(Key in possible) <p>BUZZER : Set buzzer sound ON/OFF FUZZY : Set FUZZY ON/Off(Fuzzy : Overshoot suppressing function)</p>
FUNCTION1	12:54P												
OPER MODE:	PROG												
PWR MODE :	STOP												
KEY LOCK :	OFF												
BUZZER :	OFF												
FUZZY :	OFF												
<table border="1"> <tr> <td>FUNCTION2</td> <td>12:54P</td> </tr> <tr> <td>FIX OP TM:</td> <td>0 HR 0 MIN</td> </tr> <tr> <td>FIX OP TM:</td> <td>OFF</td> </tr> <tr> <td>UP SLOP:</td> <td>0.0 %/M</td> </tr> <tr> <td>DOWN SLOP:</td> <td>0.0 %/M</td> </tr> </table>	FUNCTION2	12:54P	FIX OP TM:	0 HR 0 MIN	FIX OP TM:	OFF	UP SLOP:	0.0 %/M	DOWN SLOP:	0.0 %/M	<p>FIX OP TM : Set FIX Operation time ON/OFF It is reserving function within 9999 hours and fix running is finishing after set the time</p> <p>UP SLOP : In changing the rising zone of fixed goal, it changes the fixed value at a constant change rate without rapidly changing the fixed value (refer to the Figure 2)</p> <p>DOWN SLOP : In changing the fixation of the descending zone of fixed goal, it changes the fixed value at a constant change rate without rapidly changing the fixed value.</p>		
FUNCTION2	12:54P												
FIX OP TM:	0 HR 0 MIN												
FIX OP TM:	OFF												
UP SLOP:	0.0 %/M												
DOWN SLOP:	0.0 %/M												
<table border="1"> <tr> <td>FUNCTION3</td> <td>12:54P</td> </tr> <tr> <td>SP SL :</td> <td>SP 1</td> </tr> <tr> <td>SP 1 :</td> <td>150.00</td> </tr> <tr> <td>SP 2 :</td> <td>150.00</td> </tr> <tr> <td>SP 3 :</td> <td>150.00</td> </tr> <tr> <td>SP 4 :</td> <td>150.00</td> </tr> </table>	FUNCTION3	12:54P	SP SL :	SP 1	SP 1 :	150.00	SP 2 :	150.00	SP 3 :	150.00	SP 4 :	150.00	<p>SP SL : There are 4 set points selectable, and one should be selected among them and be operated, (possible to select by DI)</p>
FUNCTION3	12:54P												
SP SL :	SP 1												
SP 1 :	150.00												
SP 2 :	150.00												
SP 3 :	150.00												
SP 4 :	150.00												
<table border="1"> <tr> <td>FUNCTION4</td> <td>12:54P</td> </tr> <tr> <td>SP RH:</td> <td>150.00</td> </tr> <tr> <td>SP RL:</td> <td>-50.00</td> </tr> <tr> <td>DSP.H:</td> <td>160.00</td> </tr> <tr> <td>DSP.L:</td> <td>-60.00</td> </tr> <tr> <td>TMU :</td> <td>HH.MM</td> </tr> </table>	FUNCTION4	12:54P	SP RH:	150.00	SP RL:	-50.00	DSP.H:	160.00	DSP.L:	-60.00	TMU :	HH.MM	<p>SP RH(RL) : RANGE HIGH(LOW) of SP DSP.H(L) : DISPLAY HIGH(LOW), upper/lower limit of numerical values shown on the screen TMU : Time unit which is applied when in operation DI SL : Settable to (0,1) when in FIX Mode and (0,1,2) when in PROG Mode (refer to table 1)</p>
FUNCTION4	12:54P												
SP RH:	150.00												
SP RL:	-50.00												
DSP.H:	160.00												
DSP.L:	-60.00												
TMU :	HH.MM												

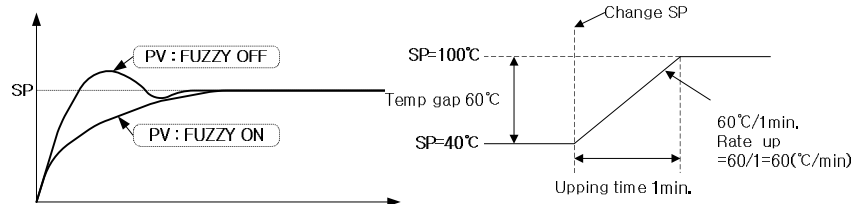

(Figure10 : Overshoot suppressing by FUZZY function)

(Figure1 : Ex. SLOPE Setting(TMU: HH.MM))

SYMBOL	PARAMETER	RANGE	DISPLAY	UNIT	DEFAULT	EDIT
OPER MODE	OPERATION MODE	PROG, FIX	Always	ABS	PROG	0
PWR MODE	POWER MODE	STOP, COLD, HOT	Always	ABS	STOP	0
KEY LOCK	KEY LOCK	OFF, ON	Always	ABS	OFF	0
BUZZER	BUZZER	OFF, ON	Always	ABS	ON	0
FUZZY	FUZZY	OFF, ON	Always	ABS	OFF	0
FIX OP TM	FIX OP TIME(HOUR)	0 ~ 9999 HR	Always	HR	0 HR	0
	FIX OP TIME(MIN)	0 ~ 59 MIN	Always	MIN	0 MIN	0
FIX OP TM	FIX OP TIME	OFF, ON	Always	ABS	OFF	0
UP SLOP	UP SLOP	EUS(0.0~100.0%) /MIN (TMU)	Always	EUS /MIN	EUS(0.0%) /MIN	0
DOWN SLOP	DOWN SLOP	EUS(0.0~100.0%) /MIN (TMU)	Always	EUS /MIN	EUS(0.0%) /MIN	0
SP SL	SET POINT SELECT	SP1, SP2, SP3, SP4	Always	ABS	SP1	0
SP1	SET POINT1	SP RL ~SP RH	Always	EU	SP RL	0
SP2	SET POINT2	SP RL ~SP RH	Always	EU	SP RL	0
SP3	SET POINT3	SP RL ~SP RH	Always	EU	SP RL	0
SP4	SET POINT4	SP RL ~SP RH	Always	EU	SP RL	0
SP RH	SET POINT RANGE HIGH	SP RL+1digit~EU(100.0%)	Always	EU	EU(100.0%)	0
SP RL	SET POINT RANGE LOW	EU(0.0%)~SP RH-1digit	Always	EU	EU(0.0%)	0
DSP.H	DISPLAY HIGH	DSP.L+1digit~EU(105.0%)	Always	EU	EU(105.0%)	0
DSP.L	DISPLAY LOW	EU(-5.0%)~DSP.H-1digit	Always	EU	EU(-5.0%)	0
TMU	TIME UNIT	HH:MM, MM:SS	Always	ABS	HH:MM	0

4.4.2 PID SET

<table border="1" style="width: 100%; border-collapse: collapse;"> <tr> <td style="text-align: right;">MAIN MENU2</td> <td style="text-align: left;">12:54P</td> </tr> <tr> <td>FUNCTION</td> <td>BIAS SET</td> </tr> <tr> <td>PID SET</td> <td>US1</td> </tr> <tr> <td>ALARM SET</td> <td>US2</td> </tr> <tr> <td>AT TUNING</td> <td>COMM SET</td> </tr> <tr> <td>AUTO/MAN</td> <td></td> </tr> </table>	MAIN MENU2	12:54P	FUNCTION	BIAS SET	PID SET	US1	ALARM SET	US2	AT TUNING	COMM SET	AUTO/MAN		MAIN MENU 2 screen to enter PID SET
MAIN MENU2	12:54P												
FUNCTION	BIAS SET												
PID SET	US1												
ALARM SET	US2												
AT TUNING	COMM SET												
AUTO/MAN													
<table border="1" style="width: 100%; border-collapse: collapse;"> <tr> <td style="text-align: right;">PID ZONE</td> <td style="text-align: left;">12:54P</td> </tr> <tr> <td>REF.P1</td> <td>: 150.00 °C</td> </tr> <tr> <td>REF.P2</td> <td>: 150.00 °C</td> </tr> <tr> <td>REF.P3</td> <td>: 150.00 °C</td> </tr> <tr> <td>REF.HYS</td> <td>: 6.00 °C</td> </tr> <tr> <td>CTR.MODE</td> <td>: D.PV</td> </tr> </table>	PID ZONE	12:54P	REF.P1	: 150.00 °C	REF.P2	: 150.00 °C	REF.P3	: 150.00 °C	REF.HYS	: 6.00 °C	CTR.MODE	: D.PV	PID SET screen REF.P1(P2) : Set limit value for selecting ZONE PID on temperature SPAN. REF.DEV : Set deviation when selecting deviation PID. REF.HYS : Set the width of hysteresis when selecting PID group in Zone PID. MODE As PID control mode, it divides D,PV from D,DV CTR MODE : Set D,DV or D,PV as PROG mode in PID control If you select the D,DV on the control mode, overshoot is small but it take a long time for reaching the TSP because the MV variation rate is low. Selecting the D,PV, overshoot is big but it is faster than the D,DV for reaching the TSP because the MV variation rate is high.
PID ZONE	12:54P												
REF.P1	: 150.00 °C												
REF.P2	: 150.00 °C												
REF.P3	: 150.00 °C												
REF.HYS	: 6.00 °C												
CTR.MODE	: D.PV												

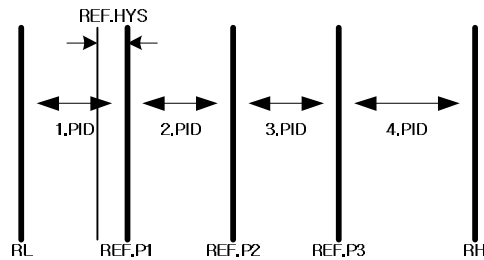

<table border="1" style="width: 100%; border-collapse: collapse;"> <tr> <td style="text-align: right;">PID 1</td> <td style="text-align: left;">12:54P</td> </tr> <tr> <td>P : 5.0%</td> <td>PC: 5.0%</td> </tr> <tr> <td>I : 120S</td> <td>IC: 120S</td> </tr> <tr> <td>D : 30S</td> <td>DC: 30S</td> </tr> <tr> <td>OH: 100.0%</td> <td>OH: 100.0%</td> </tr> <tr> <td>DB: 10.0%</td> <td>MR: 50.0%</td> </tr> </table>	PID 1	12:54P	P : 5.0%	PC: 5.0%	I : 120S	IC: 120S	D : 30S	DC: 30S	OH: 100.0%	OH: 100.0%	DB: 10.0%	MR: 50.0%	Input values of P, I, D, Pc, Ic, Dc on PID 1~4(H/C Type) OH : Set upper-limit of the range of operations of control output. DB : Parameter for setting DEAD BAND of Heating/Cooling operations for H/C TYPE. MR : Parameter for applying values manually setted to items on the integral time(I) of PID operations when the integral time(I) is '0' in controlling PID.
PID 1	12:54P												
P : 5.0%	PC: 5.0%												
I : 120S	IC: 120S												
D : 30S	DC: 30S												
OH: 100.0%	OH: 100.0%												
DB: 10.0%	MR: 50.0%												
<table border="1" style="width: 100%; border-collapse: collapse;"> <tr> <td style="text-align: right;">PID 1</td> <td style="text-align: left;">12:54P</td> </tr> <tr> <td>P : 5.0%</td> <td>MR: 50.0%</td> </tr> <tr> <td>I : 120S</td> <td></td> </tr> <tr> <td>D : 30S</td> <td></td> </tr> <tr> <td>OH: 100.0%</td> <td></td> </tr> <tr> <td>OL: 0.0%</td> <td></td> </tr> </table>	PID 1	12:54P	P : 5.0%	MR: 50.0%	I : 120S		D : 30S		OH: 100.0%		OL: 0.0%		Input P,I,D value on PID1~4 (STD TYPE) OH, OL : Set upper-limit and lower-limit of the range of operations of control output. MR : Parameter for applying values manually setted to items on the integral hour of PID operation when the integral hour(I) is '0' in controlling PID.
PID 1	12:54P												
P : 5.0%	MR: 50.0%												
I : 120S													
D : 30S													
OH: 100.0%													
OL: 0.0%													

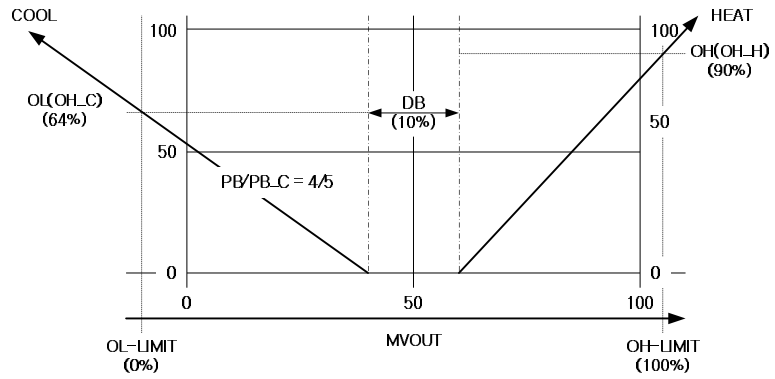

Figure13 : Ex. HEAT=PID, COOL=PID

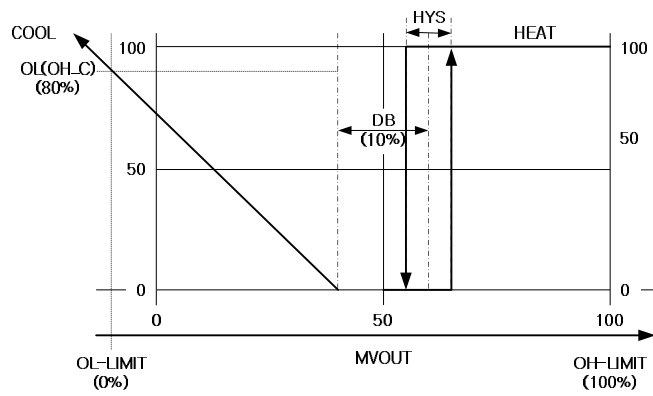

Figure4 : Ex. HEAT=ON/OFF, COOL=PID

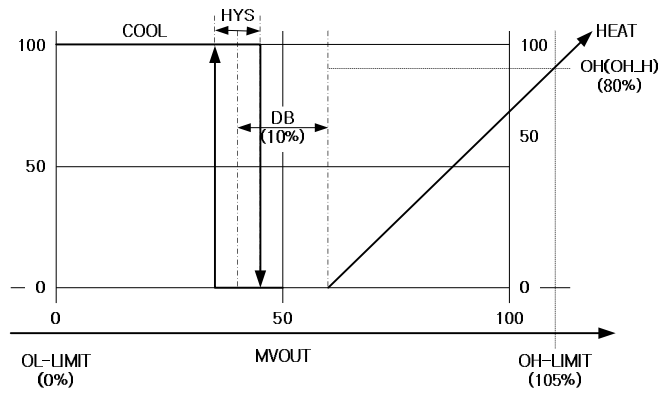

Figure15 : HEAT = PID, COOL = ON/OFF

1. ON/OFF MODE

- Use after fixing ON/OFF control when P=0 in PID group,
- MVOUT can be fixed by RELAY control output when in ON/OFF MODE operations, and be able to fix ONOFF HYS PARA.
- It is applied to OFF / ON zone by (ONOFF HYS)/2.

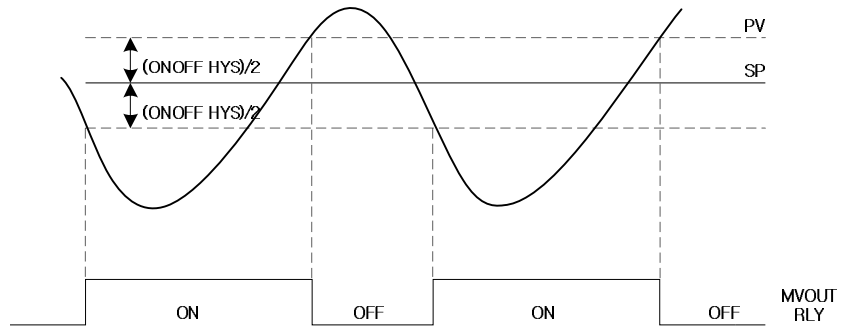

Figure16 : ON/OFF control

SYMBOL	PARAMETER	RANGE	DISPLAY	UNIT	DEFAULT	EDIT
REF.P1	REFERENCE POINT1	EU(0.0%)~EU(100.0%) REF.1≤REF.2≤REF.3	Always	EU	EU(100.0%)	○
REF.P2	REFERENCE POINT2		Always	EU	EU(100.0%)	○
REF.P3	REFERENCE POINT3		Always	EU	EU(100.0%)	○
REF.HYS	REFERENCE HYSTERESIS	EUS(0.0~10.0%)	Always	EUS	EUS(0.3%)	○
CTR.MODE	CONTROL MODE	D,DV, D,PV	Always	ABS	D,PV	○
P	HEAT PROPORTIONAL BAND	0.0 ~ 999.9% (0=ON/OFF)	Always	%	5.0%	○
I	HEAT TEMP INTEGRAL	0 ~ 6000s	Always	sec.	120 sec.	○
D	HEAT DERIVATIVE TIME	0 ~ 6000s	Always	sec.	30 sec.	○
Pc	COOL PROPORTIONAL BAND	0.0 ~ 999.9% (0=ON/OFF)	H/C type	%	5.0%	○
Ic	COOL TEMP INTEGRAL	0 ~ 6000s	H/C type	sec.	120 sec.	○
Dc	COOL DERIVATIVE TIME	0 ~ 6000s	H/C type	sec.	30 sec.	○
OH	HEAT OUTPUT LIMIT HIGH	OL+1 digit ~ 100.0% 0.0 ~ 100.0% (H/C TYPE)	Always	%	100.0%	○
OL	HEAT OUTPUT LIMIT LOW	0.0% ~ OH-1 digit	STD type	%	0.0%	○
OH	COOL OUTPUT LIMIT HIGH	0.0 ~ 100.0%	H/C type	%	100.0%	○
DB	DEAD BAND	-100.0%~15.0%	H/C type	%	3.0%	○
MR	MANUAL RESET	-5.0~105.0%	Always	%	50.0%	○

4.4.3 ALARM SET

MAIN MENU2 12:54P FUNCTION BIAS SET PID SET US1 ALARM SET US2 AT TUNING COMM SET AUTO/MAN	MAIN MENU 2 screen to enter PID SET
ALARM SET1 12:54P POINT : 150.00 %	POINT : Set value for ALARM
ALARM SET2 12:54P POINT : 150.00 %	POINT : Set value for ALARM
ALARM SET3 12:54P HIGH DEV. : -50.00 % LOW DEV. : -50.00 %	HIGH DEV : High Deviation for Deviation Operation, LOW DEV : Low Deviation for Deviation Operation,
ALARM SET4 12:54P HIGH DEV. : -50.00 % LOW DEV. : -50.00 %	HIGH DEV : High Deviation for Deviation Operation, LOW DEV : Low Deviation for Deviation Operation,



NOTE

Alarm is working on even STOP state

SYMBOL	PARAMETER	RANGE	DISPLAY	UNIT	DEFAULT	EDIT
POINT	ALARM POINT	EUS(-100,0~100,0%)	upper- limit of value	EU	EUS(100,0%)	○
			lower- limit of value	EU	EUS(0,0%)	○
HIGH DEV.	HIGH DEVIATION	EUS(-100,0~100,0%)*1	Deviation Operation	EUS	EUS(100,0%)	○
LOW DEV.	LOW DEVIATION	EUS(-100,0~100,0%)*1	Deviation Operation	EUS	EUS(0,0%)	○

*1 : EUS(-100,0~100,0%) ~ EUS(-100,0%) is settable to Max -999,9

4.4.4 AUTO TUNING SET

<pre> MAIN MENU2 12:54P FUNCTION BIAS SET PID SET US1 ALARM SET US2 AT TUNING COMM SET AUTO/MAN </pre>	MAIN MENU 2 screen to enter AUTO TUNING SET
<pre> AUTO TUNING 12:54P TUNING : OFF AT ZONE : ZONE </pre>	AUTO MODE Operation, TUNING : Depending on the AT setting value, calculated PID value will be saved in each relevant PID zone. AT ZONE : ZONE à It carries out ZONE PID AUTO TUNING SEG à It carries out SEG PID AUTO TUNING

SYMBOL	PARAMETER	RANGE	DISPLAY	UNIT	DEFAULT	EDIT
TUNING	AUTO TUNING	OFF, 1~4, AUTO (0,1% of AT POINT)	Always	ABS	OFF	○
AT ZONE	AT ZONE	ZONE, SEG	Always	ABS	SEG	○

※ AT TUNING Operation

1. ZONE PID AUTO TUNING

1.1 Set value of AT TUNING : OFF, 1~4, AUTO SET

1.2 Operation

- AT ZONE : When setting ZONE, it carries out ZONE PID AUTO TUNING process.
- 1 : PID zone 1 AT.
 - When starting to carry out AT process, progress SEG keeps Holding and SP will be changed to TUNING SP.
 - $PID1\ AT.SP = IN.RL + (REF.P1 - IN.RL) / 2$
 - After complete of AT, it starts to carry out hold SEG with the preceding SP before AT.
- 2 : PID zone 2 AT.
 - When starting to carry out AT process, progress SEG keeps Holding and SP will be changed to TUNING SP.
 - $PID2\ AT.SP = REF.P1 + (REF.P2 - REF.P1) / 2$
 - After complete of AT, it starts to carry out hold SEG with the preceding SP before AT.
- 3 : PID zone 3 AT.
 - When starting to carry out AT process, progress SEG keeps Holding and SP will be changed to TUNING SP.
 - $PID3\ AT.SP = REF.P2 + (REF.P3 - REF.P2) / 2$
 - After complete of AT, it starts to carry out hold SEG with the preceding SP before AT.
- 4 : PID zone 4 AT.
 - When starting to carry out AT process, progress SEG keeps Holding and SP will be changed to TUNING SP.
 - $PID4\ AT.SP = REF.P3 + (REF.P4 - REF.P3) / 2$
 - After complete of AT, it starts to carry out hold SEG with the preceding SP before AT.
- AUTO : Carry out AUTO AT process PID zone 1 to 4 orderly.
 - When starting to carry out AT process, progress SEG keeps Holding and SP will be changed to TUNING SP.
 - Carry out AUTO AT process PID zone 1 to 4
 - $PID1\ AT.SP = IN.RL + (REF.P1 - IN.RL) / 2$
 - $PID2\ AT.SP = REF.P1 + (REF.P2 - REF.P1) / 2$
 - $PID3\ AT.SP = REF.P2 + (REF.P3 - REF.P2) / 2$
 - $PID4\ AT.SP = REF.P3 + (IN.RH - REF.P3) / 2$
 - After complete of AT, it starts to carry out hold SEG with the preceding SP before AT.

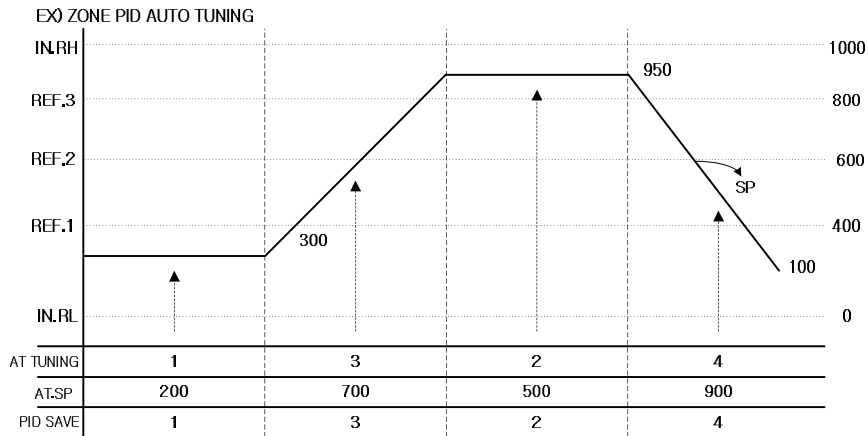

Figure17 : Ex. Of ZONE PID AUTO TUNING

2. SEG PID AUTO TUNING

2.1 Setting value of AT TUNING : OFF, 1~4

2.2 Operation

- AT ZONE : When setting SEG. it carries out SEG PID AUTO TUNING.
- 1~4 : Calculated PID value from AT with fixed NSP will be saved in each relevant PID zone.
- NSP will be fixed, if AT is started during PROG running.
- Carry out AT process with fixed NSP.
- After complete of AT process, carry out SEG process with former SP before AT.
- Depending on AT setting value, calculated PID value will be saved in each relevant PID zone.

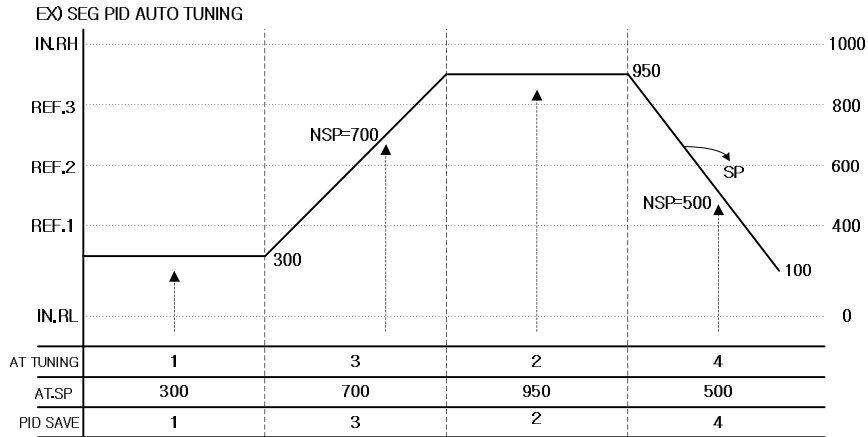

Figure18 : Ex of SEG PID AUTO TUNING

4.4.5 AM MODE

<pre> MAIN MENU2 12:54P FUNCTION BIAS SET PID SET US1 ALARM SET US2 AT TUNING COMM SET AUTO/MAN </pre>	<p>MAIN MENU 2 screen to enter AUTO/MAN SET. It can be changed only when FIX MODE. (During AT process, this parameter can not be changed)</p>
--	---

<pre> AUTO/MAN 12:54P A/M.MODE : AUTO </pre>	<p>This parameter is to set control mode of AUTO or MANUAL. MV can be set by key input on Operation screen.</p>
---	---

SYMBOL	PARAMETER	RANGE	DISPLAY	UNIT	DEFAULT	EDIT
AM MODE	AUTO/MANUAL MODE	AUTO/MAN	Always (Selectable On FIX Mode)	ABS	AUTO	0

4.4.6 BIAS SET

<table border="0"> <tr> <td style="border: 1px solid black; padding: 2px;">MAIN MENU2</td> <td style="border: 1px solid black; padding: 2px;">12:54P</td> </tr> <tr> <td style="border: 1px solid black; padding: 2px;">FUNCTION</td> <td style="border: 1px solid black; padding: 2px;">BIAS SET</td> </tr> <tr> <td style="border: 1px solid black; padding: 2px;">PID SET</td> <td style="border: 1px solid black; padding: 2px;">US1</td> </tr> <tr> <td style="border: 1px solid black; padding: 2px;">ALARM SET</td> <td style="border: 1px solid black; padding: 2px;">US2</td> </tr> <tr> <td style="border: 1px solid black; padding: 2px;">AT TUNING</td> <td style="border: 1px solid black; padding: 2px;">COMM SET</td> </tr> <tr> <td style="border: 1px solid black; padding: 2px;">AUTO/MAN</td> <td></td> </tr> </table>	MAIN MENU2	12:54P	FUNCTION	BIAS SET	PID SET	US1	ALARM SET	US2	AT TUNING	COMM SET	AUTO/MAN		MAIN MENU 2 screen to enter BIAS SET
MAIN MENU2	12:54P												
FUNCTION	BIAS SET												
PID SET	US1												
ALARM SET	US2												
AT TUNING	COMM SET												
AUTO/MAN													
<table border="0"> <tr> <td style="border: 1px solid black; padding: 2px;">BIAS SET</td> <td style="border: 1px solid black; padding: 2px;">12:54P</td> </tr> <tr> <td style="border: 1px solid black; padding: 2px;">BIAS :</td> <td style="border: 1px solid black; padding: 2px;">0.0 °</td> </tr> </table>	BIAS SET	12:54P	BIAS :	0.0 °	BIAS : Collective INPUT BIAS								
BIAS SET	12:54P												
BIAS :	0.0 °												

SYMBOL	PARAMETER	RANGE	DISPLAY	UNIT	DEFAULT	EDIT
BIAS	BIAS VALUE	EUS(-100.0~100.0%)	Always	EUS	EUS(0.0%)	○

4.4.7 USER SCREEN SET (US1, US2)

<pre> MAIN MENU2 12:54P FUNCTION BIAS SET PID SET US1 ALARM SET US2 AT TUNING COMM SET AUTO/MAN </pre>	<p>MAIN MENU 2 screen to enter USER SCREEN1</p>
<pre> US1:ALARM 12:54P NONE FILE EDIT FUNCTION PTN SUB A/M SEG ALM ALARM TIME SG REPEAT </pre>	<p>Setting value of US1 will be applied to MAIN MENU 1</p>
<pre> MAIN MENU2 12:54P FUNCTION BIAS SET PID SET US1 ALARM SET US2 AT TUNING COMM SET AUTO/MAN </pre>	<p>MAIN MENU 2 screen to enter USER SCREEN 2</p>
<pre> US2:FILE EDIT 12:54P NONE FILE EDIT FUNCTION PTN SUB A/M SEG ALM ALARM TIME SG REPEAT </pre>	<p>Setting value of US2 will be applied to MAIN MENU 1</p>

SYMBOL	PARAMETER	RANGE	DISPLAY	UNIT	DEFAULT	EDIT
US1	USER SCREEN 1	NONE,FUNCTION,AM, ALARM,REPEAT, FILE EDIT,PTN SUB, SEG ALM,TIME SG	Always	ABS	NONE	○
US2	USER SCREEN 2	NONE,FUNCTION,AM, ALARM,REPEAT, FILE EDIT,PTN SUB, SEG ALM,TIME SG	Always	ABS	NONE	○

4.4.8 COMMUNICATION SET

<table border="1"> <tr> <td>MAIN MENU2</td> <td>12:54P</td> </tr> <tr> <td>FUNCTION</td> <td>BIAS SET</td> </tr> <tr> <td>PID SET</td> <td>US1</td> </tr> <tr> <td>ALARM SET</td> <td>US2</td> </tr> <tr> <td>AT TUNING</td> <td>COMM SET</td> </tr> <tr> <td>AUTO/MAN</td> <td></td> </tr> </table>	MAIN MENU2	12:54P	FUNCTION	BIAS SET	PID SET	US1	ALARM SET	US2	AT TUNING	COMM SET	AUTO/MAN		MAIN MENU 2 screen to enter COMMUNICATION SET
MAIN MENU2	12:54P												
FUNCTION	BIAS SET												
PID SET	US1												
ALARM SET	US2												
AT TUNING	COMM SET												
AUTO/MAN													

<table border="1"> <tr> <td>COMM SET</td> <td>12:54P</td> </tr> <tr> <td>PROT.:</td> <td>SYNCR</td> </tr> <tr> <td>BPS :</td> <td>9600</td> </tr> <tr> <td>PRTY.:</td> <td>NONE</td> </tr> <tr> <td>S.BIT:</td> <td>1 D.LEN: 8</td> </tr> <tr> <td>ADDR.:</td> <td>1 RP.TM: 0</td> </tr> </table>	COMM SET	12:54P	PROT.:	SYNCR	BPS :	9600	PRTY.:	NONE	S.BIT:	1 D.LEN: 8	ADDR.:	1 RP.TM: 0	PROT : Protocol BPS : Speed (Bit per sec) PRTY : Parity S.BIT : Stop bit D.LEN : Data length ADDR : Address RP.TM : Response time
COMM SET	12:54P												
PROT.:	SYNCR												
BPS :	9600												
PRTY.:	NONE												
S.BIT:	1 D.LEN: 8												
ADDR.:	1 RP.TM: 0												

SYMBOL	PARAMETER	RANGE	DISPLAY	UNIT	DEFAULT	EDIT
PROT.	PROTOCOL	PCLK0, PCLK1, MDB.A, MDB.R, SYNCR	When Option	ABS	PCLK1	0
BPS	BAUD RATE	600, 1200, 2400, 4800, 9600, 19200	When Option	ABS	9600	0
PRTY.	PARITY	NONE, EVEN, ODD	When Option	ABS	NONE	0
S,BIT	STOP BIT	1, 2	When Option	ABS	1	0
D,LEN	DATA LENGTH	7, 8	When Option	ABS	8	0
ADDR.	ADDRESS	1~99 (Max.31set available)	When Option	ABS	1	0
RP,TM	RESPONSE TIME	0 ~ 10	When Option	ABS	0	0

4.5 SETUP MENU

4.5.1 INPUT SET

<p>SETUP PASS 12:54P</p> <p>PASS: 0</p>	<p>PASSWORD screen to enter SETUP MENU. This screen will be displayed by SHIFT+SET KEY for 6 sec. on Operation screen. After filling up password, SETUP MENU will be displayed. And Operation screen will return by pushing SET KEY again for 3 sec. or NO KEY input for 60 sec.</p>
<p>SETUP MENU 12:54P</p> <p>INPUT DO PTN SUB OUTPUT BIAS SEG ALM RET DI REPEAT INNER PWD TIME SG ALARM FILE ON/OFF</p>	<p>SETUP MENU screen to enter INPUT SET. Operation screen will return by pushing SET KEY again for 3 sec. or NO KEY input for 60 sec.</p>
<p>INPUT SET1 12:54P</p> <p>SEN. GROUP: T C SENSOR : TC-K0 SEN. UNIT : °C FILTER : 0 SEC</p>	<p>SEN. GROUP : Divide the type of input sensor by TC, RTD, and DCV. SENSOR : Input sensor. (refer to table 2) FILTER : Parameter fixed up for alleviating the shake of PV caused from unmeasured disturbance & noise.</p>
<p>INPUT SET2 12:54P</p> <p>RNG. HIGH: 1370 °C RNG. LOW : -200 °C</p>	<p>RNG.HIGH(LOW) : Set a range of use for each sensor.</p>
<p>INPUT SET3 12:54P</p> <p>S.OPN SEL: U P RJC. SEL: 0 N</p>	<p>S.OPN SEL : It is a parameter for selecting the direction of operations of PV when in Sensor-Open. When it is 'UP', PV operates to the upper direction of sensor input, and to the lower direction of sensor input when it is 'DOWN'. RJC. SEL : It is a parameter for setting whether to use Reference Junction Compensation.</p>
<p>INPUT SET1 12:54P</p> <p>SEN. GROUP: DCV SENSOR : 0.4-2.0U SEN. UNIT : °C FILTER : 0 SEC</p>	<p>SEN. GROUP : Divide the type of input sensor by TC, RTD, and DCV. SENSOR : Input sensor. (refer to table 2) FILTER : Parameter fixed up for alleviating the shake of PV caused from unmeasured disturbance & noise.</p>
<p>INPUT SET2 12:54P</p> <p>RNG. HIGH: 2.000 U RNG. LOW : 0.400 U DOT. POS : 2 SCL. HIGH: 100.00 °C SCL. LOW : 0.00 °C</p>	<p>RNG.HIGH(LOW) : Set a range of use for each sensor. DOT. POS : Is indicated when in DCV, and indicates a number below decimal points. SCL. HIGH(LOW) : When input is DCV, set scale on input range</p>

Table 2 : Type of Input Sensor

※display range : -5% ~ +105%

No.	TYPE	Temp.Range(°C)	Temp.Range(°F)	Group	DISP
1	K0	-200~1370	-300~2500	T/C	TC-K0
2	K1	-200.0~1370.0	-300.0~2500.0		TC-K1
3	K2	-200.0~1000.0	0.0~2300.0		TC-K2
4	J	-200.0~1200.0	-300.0~2300.0		TC-J
5	E	-200.0~1000.0	-300.0~1800.0		TC-E
6	T	-200.0~400.0	-300.0~750.0		TC-T
7	R	0.0~1700.0	32~3100		TC-R
8	B	0.0~1800.0	32~3300		TC-B
9	S	0.0~1700.0	32~3100		TC-S
10	L	-200.0~900.0	-300.0~1600.0		TC-L
11	N	-200.0~1300.0	-300.0~2400.0		TC-N
12	U	-200.0~400.0	-300.0~750.0		TC-U
13	W	0.0~2300.0	32~4200		TC-W
14	Platinel II	0.0~1390.0	32.0~2500.0		TC-P
15	PTA	-200.0~850.0	-300.0~1560.0	RTD	PT A
16	PTB	-200.0~500.0	-300.0~1000.0		PT B
17	PTC	-50.00~150.00	-148.0~300.0		PT C
18	JPTA	-200.0~500.0	-300.0~1000.0		JPT A
19	JPTB	-50.00~150.00	-148.0~300.0		JPT B
20	0.4~2.0V	0.400~2.000V		DCV	0.4~2.0V
21	1~5V	1.000~5.000V			1~5V
22	0~10V	0.00~10.00V			0~10V
23	-10~20mV	-10.00~20.00mV		mV	-10~20mV
24	0~100mV	0.0~100.0mV			0~100mV

Symbol	Parameter	Range	Diaplay	Unit	Default	EDIT
SEN. GROUP	SENSOR GROUP	T/C, RTD, DCV	Always	ABS	T/C	0
SENSOR	SENSOR TYPE	Depending on SENSOR	Always	ABS	TC-K1	0
SEN. UNIT	SENSOR UNIT	°C, °F	T/C, RTD	ABS	°C	0
SEN. UNIT	SENSOR UNIT	°C, °F, SPACE, %, Pa, mV, V, %Rh, OHM	DCV	ABS	°C	0
FILTER	FILTER	120sec	Always	SEC	0 SEC	0
RNG.HIGH	RANGE HIGH	RL+1digit~EU(100.0%)	Always	EU	EU(100.0%)	0
RNG.LOW	RANGE LOW	EU(0.0%)~EH-1digit	Always	EU	EU(0.0%)	0
DOT.POS	DOT POSITION	0~3	DCV	ABS	2	0
SCL.HIGH	SCALE HIGH	SL+1digit~300.00	DCV	ABS	100.00	0
SCL.LOW	SCALE LOW	-19.99~SH-1digit	DCV	ABS	0.00	0
B.OUT SEL	BURN OUT SELECT	OFF, UP, DOWN	Always	ABS	UP	0
R.JC.SEL	Reference Junction Compensation	ON, OFF	Always	ABS	ON	0
DISP FILT	DISPLAY FILTER	0 ~ 120sec	SP791	ABS	0sec	0
PWR. FREQ	POWER FREQUENCY	60, 50Hz	SP791	ABS	60Hz	0

4.5.2 OUTPUT SET

<p>SETUP MENU 12:54P INPUT DO PTN SUB OUTPUT BIAS SEG ALM RET DI REPEAT INNER PWD TIME SG ALARM FILE ON/OFF</p>	<p>SETUP MENU screen to enter OUTPUT SET. Operation screen will return by pushing SET KEY again for 3 sec. or NO KEY input for 60 sec.</p>
<p>OUTPUT SET1 12:54P OUT1:HEAT OUT2:NONE OUT3: RET SCR.RANGE: 4-20 mA OUT4:NONE SCR.RANGE: 4-20 mA</p>	<p>OUT1 : Set output type of OUTPUT1 OUT2 : Set output type of OUTPUT2 OUT3 : Set output type of OUTPUT3 OUT4 : Set output type of OUTPUT4 SCR.RANGE : Set output type of OUTPUT3,4(0-20, 4-20mA)</p>
<p>OUTPUT SET2 12:54P RELAY SEL: NONE CYCLE : 1 S AT. GAIN : 1.0 % DIRECTION: REVR.</p>	<p>RELAY SEL : Set output type of RELAY CYCLE : Set output cycle DIRECT : Set reverse/forward for PID control AT GAIN : The parameter to set proportional PID control by obtaining AUTO TUNING. Reduce AT-G, Cycle time became rapid. Increase AT-G, control status became more stable. Smaller value, will become more hunting.</p>

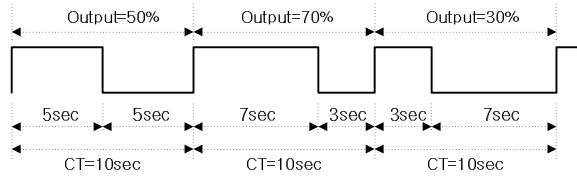

(Figure19 : Example of Control Output in CT = 10 Sec)

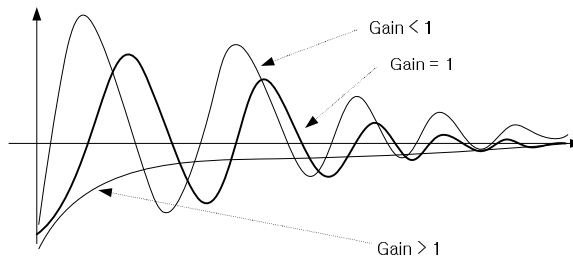

(Figure20 : AT GAIN)

<p>OUTPUT SET3 12:54P</p> <p>ARW SET : 100.0 %</p> <p>OPR SET : 100.0 %/S</p> <p>ONOFF HYS : 10.00 °</p> <p>PRESET OT : 100.0 %</p>	<p>ARW SET: It is effective method for the control at the external shock, not running I=0. When use ARW Function, Overshoot occur little, PV is flattern quickly.</p> <p>OPR SET : Control the variance rate of output</p> <p>PRESET OT : Cut an output from the calculation of PID when in A/D ERROR or BURN OUT in AUTO MODE, and output PRESET OUT. (Except that you should output MVOUT=100% when it is over PRESET OUT=0%, and output MVOUT=0% when it is below PRESET OUT=0%.)</p> <p>Output MAN output value regardless of ERROR when in MAN MODE.</p>
<p>OUTPUT SET1 12:54P</p> <p>OUT1:HEAT OUT2:COOL</p> <p>OUT3: RET</p> <p>SCR.RANGE: 4-20 mA</p> <p>OUT4:NONE</p> <p>SCR.RANGE: 4-20 mA</p>	<p>H/C TYPE</p> <p>OUT1 : Set output type of HEAT OUTPUT1</p> <p>OUT2 : Set output type of COOL OUTPUT2</p> <p>OUT3 : Set output type of OUTPUT3</p> <p>OUT4 : Set output type of OUTPUT4</p> <p>SCR.RANGE: Set output type of OUTPUT3,4(0-20, 4-20mA)</p>
<p>OUTPUT SET2 12:54P</p> <p>RELAY SEL : NONE</p> <p>HEAT CYCL : 1 S</p> <p>COOL CYCL : 1 S</p> <p>ARW SET : 100.0 %</p>	<p>H/C TYPE</p> <p>RELAY SEL : Set type of RELAY OUTPUT.</p> <p>HEAT CYCLE : Set HEAT OUTPUT CYCLE time.</p> <p>COOL CYCLE : Set COOL OUTPUT CYCLE time.</p> <p>ARW SET: It is effective method for the control at the external shock,</p>
<p>OUTPUT SET3 12:54P</p> <p>HEAT AT.G: 1.0 %</p> <p>COOL AT.G: 1.0 %</p> <p>DIRECTION: REUR.</p>	<p>H/C TYPE</p> <p>HEAT AT.G : GAIN value for HEAT</p> <p>COOL AT.G : GAIN value for COOL</p> <p>DIRECT : Set reverse/forward for PID control</p>
<p>OUTPUT SET4 12:54P</p> <p>OPR SET : 100.0 %/S</p> <p>H/C HYS : 10.0 %</p> <p>HEAT PO : 0.0 %</p> <p>COOL PO : 0.0 %</p>	<p>H/C TYPE</p> <p>OPR SET : Control the variance rate of output</p> <p>HEAT PO : HEAT PRESET OUTPUT</p> <p>COOL PO : COOL PRESET OUTPUT</p>

Symbol	Parameter	Range	Display	Unit	Default	Edit
OUT1	OUTPUT 1	HEAT, NONE	ST'D TYPE	ABS	HEAT	0
		HEAT, COOL, NONE	H/C TYPE	ABS	HEAT	0
OUT2	OUTPUT 2	HEAT, NONE	ST'D TYPE	ABS	NONE	0
		HEAT, COOL, NONE	H/C TYPE	ABS	COOL	0
OUT3	OUTPUT 3	HEAT, RET, NONE	ST'D TYPE	ABS	RET	0
		HEAT, COOL, RET, NONE	H/C TYPE	ABS	RET	0
OUT4	OUTPUT 4	HEAT, RET, NONE	ST'D TYPE	ABS	NONE	0
		HEAT, COOL, RET, NONE	H/C TYPE	ABS	NONE	0
SCR,RANGE	SCR,RANGE	0~20mA, 4~20mA	Always	ABS	4~20mA	0
RELAY SEL	RELAY SELECT	HEAT, NONE	ST'D TYPE	ABS	NONE	0
		HEAT, COOL, NONE	H/C TYPE	ABS	NONE	0
CYCLE	CYCLE	1 ~ 300s	ST'D TYPE	sec	2 sec.	0
HEAT CYCL	HEAT CYCLE	1 ~ 300s	H/C TYPE	sec	2 sec.	0
COOL CYCL	COOL CYCLE	1 ~ 300s	H/C TYPE	sec	2 sec.	0
AT,GAIN	AUTO GAIN	0.1 ~ 10.0%	ST'D TYPE	%	1.0%	0
DIRECTION	DIRECTION	REVR, FORW	Always	ABS	REVR	0
ARW SET	ANTI RESET Wind-Up SET	0.0~200.0%	H/C TYPE	%	100.0%	0
			ST'D TYPE			
OPR SET	OUTPUT RATE SET	OFF, 0.1~100.0%/S	Always	%/S	OFF	0
ONOFF HYS	ON/OFF HYSTERESIS	EUS(0.0~10.0%)	ST'D TYPE	EUS	EUS(0.5%)	0
PRESET OUT	PRESET OUTPUT	-5.0~105.0%	ST'D TYPE	%	0.0%	0
HEAT AT.	HEAT AUTO GAIN	0.1~10.0%	H/C TYPE	%	1.0%	0
COOL AT.	COOL AUTO GAIN	0.1~10.0%	H/C TYPE	%	1.0%	0
H/C HYS	H/C Type HYSTERESIS	0.0~10.0%	H/C TYPE	%	0.5%	0
HEAT PO	HEAT PRESET OUTPUT	-5.0~105.0%	H/C TYPE	%	0.0%	0
COOL PO	COOL PRESET OUTPUT	-5.0~105.0%	H/C TYPE	%	0.0%	0

4.5.3 RETRANSMISSION SET

<pre> SETUP MENU 12:54P INPUT D0 PTN SUB OUTPUT BIAS SEG ALM RET DI REPEAT INNER PWD TIME SG ALARM FILE ON/OFF </pre>	<p>SETUP MENU screen to enter RETRANSMISSION SET. Operation screen will return by pushing SET KEY again for 3 sec, or NO KEY input for 60 sec.</p>
<pre> TEMP RET. 12:54P KIND : P U RNG. HIGH: 150.00 ° RNG. LOW : -50.00 ° </pre>	<p>KIND : Indicates a type of RET output, and there are PV, SP, MV for Standard TYPE, and PV, SP, MV, H/MV, CMV for H/C Type. RNG.HIGH : Upper-limit of RET output RNG.LOW : Lower-limit of RET output</p>
<pre> TEMP RET. 12:54P KIND : S P RNG. HIGH: 150.0 ° RNG. LOW : -50.0 ° </pre>	<p>KIND : Indicates a type of RET output, and there are PV, SP, MV for Standard TYPE, and PV, SP, MV, H/MV, CMV for H/C Type. RNG.HIGH : Upper-limit of RET output RNG.LOW : Lower-limit of RET output</p>
<pre> TEMP RET. 12:54P KIND : M U </pre>	<p>KIND : Indicates a type of RET output, and there are PV, SP, MV for Standard TYPE, and PV, SP, MV, H/MV, CMV for H/C Type. RNG.HIGH : Upper-limit of RET output RNG.LOW : Lower-limit of RET output</p>

Symbol	Parameter	Range	Display	Unit	Default	Edit
KIND	RETRANSMISSION	PV, SP, MV	ST'D TYPE	ABS	PV	O
KIND	RETRANSMISSION	PV, SP, MV, H/MV, CMV	H/C TYPE	ABS	PV	O
RNG.HIGH	RANGE HIGH	RNG.LOW+1digit~EU(100.0%)	Select PV, SP	EU	EU(100.0%)	O
RNG.LOW	RANGE LOW	EU(0.0%)~RNG.HIGH-1digit	Select PV, SP	EU	EU(0.0%)	O

4.5.4 INNER SIGNAL (IS) SET

<table border="1" style="width: 100%; border-collapse: collapse;"> <tr><td style="text-align: right;">SETUP MENU</td><td style="text-align: left;">12:54P</td></tr> <tr><td>INPUT DO</td><td>PTN SUB</td></tr> <tr><td>OUTPUT BIAS</td><td>SEG ALM</td></tr> <tr><td>RET DI</td><td>REPEAT</td></tr> <tr><td>INNER PWD</td><td>TIME SG</td></tr> <tr><td>ALARM FILE</td><td>ON/OFF</td></tr> </table>	SETUP MENU	12:54P	INPUT DO	PTN SUB	OUTPUT BIAS	SEG ALM	RET DI	REPEAT	INNER PWD	TIME SG	ALARM FILE	ON/OFF	SETUP MENU screen to enter IS SET. Operation screen will return by pushing SET KEY again for 3 sec, or NO KEY input for 60 sec.
SETUP MENU	12:54P												
INPUT DO	PTN SUB												
OUTPUT BIAS	SEG ALM												
RET DI	REPEAT												
INNER PWD	TIME SG												
ALARM FILE	ON/OFF												
<table border="1" style="width: 100%; border-collapse: collapse;"> <tr><td style="text-align: right;">INNER SIGNAL1</td><td style="text-align: left;">12:54P</td></tr> <tr><td>KIND :</td><td>SP ◯</td></tr> <tr><td>RNG. HIGH :</td><td>-50.00 ◯</td></tr> <tr><td>RNG. LOW :</td><td>-50.00 ◯</td></tr> <tr><td>BAND :</td><td>IN.B</td></tr> <tr><td>DELAY.TM :</td><td>00.00 M.S</td></tr> </table>	INNER SIGNAL1	12:54P	KIND :	SP ◯	RNG. HIGH :	-50.00 ◯	RNG. LOW :	-50.00 ◯	BAND :	IN.B	DELAY.TM :	00.00 M.S	KIND : Set type of humidity retransmission (TSP, PV, SP) RNG.HIGH(LOW) : Range for IS BAND : Direct of IS band (IN,B/OUT,B) DELAY.TM : IS delay time INNER SIGNAL : There are 1 ~ 4 pages of IS.
INNER SIGNAL1	12:54P												
KIND :	SP ◯												
RNG. HIGH :	-50.00 ◯												
RNG. LOW :	-50.00 ◯												
BAND :	IN.B												
DELAY.TM :	00.00 M.S												

Symbol	Parameter	Range	Display	Unit	Default	EDIT
KIND	INNER SIGNAL KIND	TSP, PV, SP	Always	ABS	SP	○
RNG.HIGH	IS RANGE HIGH	EU(0.0~100.0%)	Always	EU	EU(0.0%)	○
RNG.LOW	IS RANGE LOW		Always	EU	EU(0.0%)	○
BAND	BAND DIRECT	IN,B, OUT,B	Always	ABS	IN,B	○
DELAY.TM	DELAY TIME	00,00~99,59 MM,SS	Always	TIME	00,00 MM,SS	○

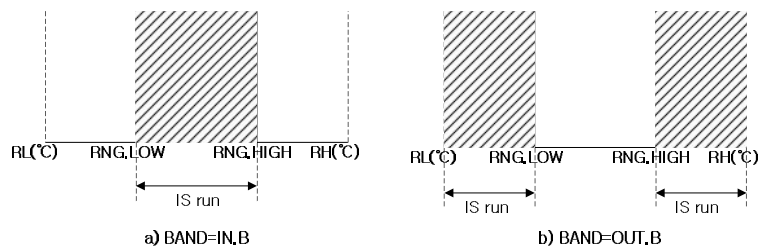

(Figure21 : Ex. Of INNER SIGNAL ZONE)

4.5.5 ALARM SET

<p>SETUP MENU 12:54P INPUT DO PTN SUB OUTPUT BIAS SEG ALM RET DI REPEAT INNER PWD TIME SG ALARM FILE ON/OFF</p>	<p>SETUP MENU screen to enter ALARM SET. Operation screen will return by pushing SET KEY again for 3 sec, or NO KEY input for 60 sec.</p>
<p>ALARM SIGNAL1 12:54P KIND : AH.F HYS : 1.00 % DELAY.TM : 00.00 M.S ALM MODE : ALL</p>	<p>This is ALARM SIGNAL 1 screen. KIND : Set type of ALARM. HYS : Set HYSTERESIS for ALARM. DELAY.TM : Set the delay time for ALRAM output ALM MODE : Set ALARM Operation mode. ALL : Always ALARM works. RUN/AM : When RUN(AUTO,MAN), ALARM works RUN/A : When RUN(AUTO), ALARM works</p>
<p>ALARM SIGNAL2 12:54P KIND : AL.F HYS : 1.00 % DELAY.TM : 00.00 M.S ALM MODE : ALL</p>	<p>This is ALARM SIGNAL 2 screen. KIND : Set type of ALARM. HYS : Set HYSTERESIS for ALARM. DELAY.TM : Set the delay time for ALRAM output ALM MODE : Set ALARM Operation mode. ALL : Always ALARM works. RUN/AM : When RUN(AUTO,MAN), ALARM works RUN/A : When RUN(AUTO), ALARM works</p>
<p>ALARM SIGNAL3 12:54P KIND : DH.F HYS : 1.0 % DELAY.TM : 00.00 M.S ALM MODE : ALL</p>	<p>This is ALARM SIGNAL 3 screen. KIND : Set type of ALARM. HYS : Set HYSTERESIS for ALARM. DELAY.TM : Set the delay time for ALRAM output ALM MODE : Set ALARM Operation mode. ALL : Always ALARM works. RUN/AM : When RUN(AUTO,MAN), ALARM works RUN/A : When RUN(AUTO), ALARM works</p>
<p>ALARM SIGNAL4 12:54P KIND : DL.F HYS : 1.0 % DELAY.TM : 00.00 M.S ALM MODE : ALL</p>	<p>This is ALARM SIGNAL 4 screen. KIND : Set type of ALARM. HYS : Set HYSTERESIS for ALARM. DELAY.TM : Set the delay time for ALRAM output ALM MODE : Set ALARM Operation mode. ALL : Always ALARM works. RUN/AM : When RUN(AUTO,MAN), ALARM works RUN/A : When RUN(AUTO), ALARM works</p>

Symbol	Parameter	Range	Display	Unit	Default	EDIT
KIND	ALARM KIND	OFF, AH.F, AL.F, DH.F, DL.F, DH.R, DL.R, DO.F, DI.F, AH.R, AL.R, AH.FS, AL.FS, DH, FS, DL.FS, DH.RS, DL.RS, DO.FS, DI.FS, AH.RS, AL.RS	Always	ABS	AH.F	0
HYS	ALARM HYSTERESIS	EUS(0.0~100.0%)	Always	EUS	EUS(0.5%)	0
DELAY.TM	DELAY TIME	00.00~99.59 MM.SS	Always	TIME	00.00 MM.SS	0
ALM MODE	ALARM MODE	ALL, RUN/AM, RUN/A	Always	ABS	ALL	0

(TABLE 2 : ALARM TYPE)

No.	Alarm Type	Output Direct		Standby		Display Data
		For	Rev	On	Off	
1	PV Upper-Limit	O		O		AH,F
2	PV Lower-Limit	O		O		AL,F
3	Deviation Upper-Limit	O		O		DH,F
4	Deviation Lower-Limit	O		O		DL,F
5	Deviation Upper-Limit		O	O		DH,R
6	Deviation Lower-Limit		O	O		DL,R
7	Deviation Upper & Lower-Limit	O		O		DO,F
8	Deviation Upper & Lower-Limit Range	O		O		DI,F
9	PV Upper-Limit		O	O		AH,R
10	PV Lower-Limit		O	O		AL,R
11	PV Upper-Limit	O			O	AH,FS
12	PV Lower-Limit	O			O	AL,FS
13	Deviation Upper-Limit	O			O	DH,FS
14	Deviation Lower-Limit	O			O	DL,FS
15	Deviation Upper-Limit		O		O	DH,RS
16	Deviation Lower-Limit		O		O	DL,RS
17	Deviation Upper & Lower-Limit	O			O	DO,FS
18	Deviation Upper & Lower-Limit Range	O			O	DI,FS
19	PV Upper-Limit		O		O	AH,RS
20	PV Lower-Limit		O		O	AL,RS

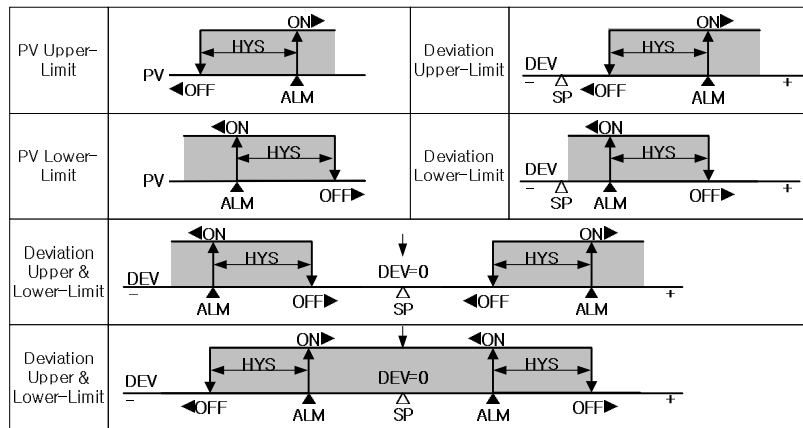

(Figure22 : ALRAM OPERATION)

4.5.6 Digital Output SET (DO)

<pre> SETUP MENU 12:54P INPUT 00 PTN SUB OUTPUT BIAS SEG ALM RET DI REPEAT INNER PWD TIME SG ALARM FILE ON/OFF </pre>	<p>SETUP MENU screen to enter DO SET. Operation screen will return by pushing SET KEY again for 3 sec. or NO KEY input for 60 sec.</p>
<pre> DO CONFIG1 12:54P IS1 : 0 TS1 : 0 IS2 : 0 TS2 : 0 IS3 : 0 TS3 : 0 IS4 : 0 TS4 : 0 RUN : 0 TS5 : 0 </pre>	<p>DO CONFIG set (1st page) Set the relay number (0~12) for IS1~4, RUN and TS1~5</p>
<pre> DO CONFIG2 12:54P AL1 : 0 S.AL1 : 0 AL2 : 0 S.AL2 : 0 AL3 : 0 S.AL3 : 0 AL4 : 0 S.AL4 : 0 ERR : 0 RELAY : 0 </pre>	<p>DO CONFIG set (2nd page) Set the relay number (0~12) for ALARM1~4, WAIT and SEG ALARM1~4(0~12) Set the relay number (0~8) for Relay Output</p>
<pre> DO CONFIG3 12:54P T1 : 0 00.00 M.S T2 : 0 00.00 M.S T3 : 0 00.00 M.S T4 : 0 00.00 M.S </pre>	<p>DO CONFIG set (3rd page) Set the relay number (0~12) for T1~T4</p>
<pre> DO CONFIG3 12:54P UP : 0 0.0 c SOAK : 0 0 MIN DOWN : 0 0.0 c PTEND : 0 0 SEC HOLD : 0 0 MIN </pre>	<p>DO CONFIG set (4th page) Set the relay number (0~12) for UP, SOAK, T,DOWN and set temperature, operating time for each UP : Output until X°C [X=TSP - set temperature] SOAK : Output until X min [X=SOAK zone time - set time] DOWN : Output until X°C [X=T,SP - set temperature] Set the relay number (0~12) for PTEND and set Output time Set the relay number (0~12) for HOLD and set Output time</p>

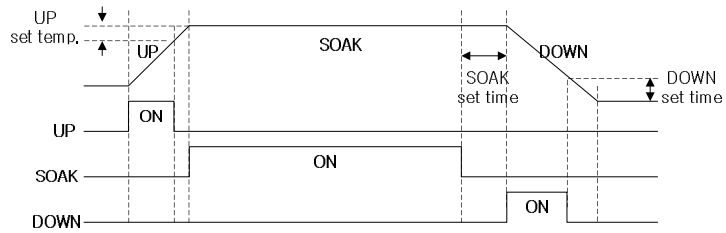

It is working UP, SOAK, DOWN on PROG Mode,
only is working UP, DOWN on FIX Mode SLOP

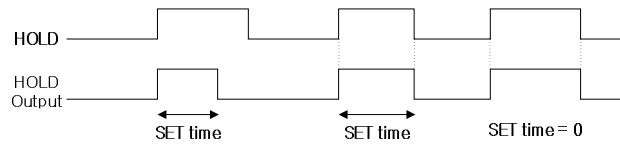

(Figure23 : Ex. Of UP, SOAK, DOWN, HOLD)

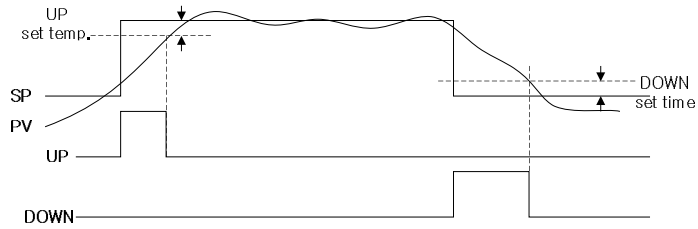

(Figure24 : Ex.of UP, DOWN output when changing FIX Mode SP)

Symbol	Parameter	Range	Display	Unit	Default	EDIT
IS1	INNER SIGNAL1	0 ~ 12	Always	ABS	0	0
IS2	INNER SIGNAL2	0 ~ 12	Always	ABS	0	0
IS3	INNER SIGNAL3	0 ~ 12	Always	ABS	0	0
IS4	INNER SIGNAL4	0 ~ 12	Always	ABS	0	0
RUN	RUN	0 ~ 12	Always	ABS	0	0
TS1	TIME SIGNAL1	0 ~ 12	Always	ABS	0	0
TS2	TIME SIGNAL2	0 ~ 12	Always	ABS	0	0
TS3	TIME SIGNAL3	0 ~ 12	Always	ABS	0	0
TS4	TIME SIGNAL4	0 ~ 12	Always	ABS	0	0
TS5	TIME SIGNAL5	0 ~ 12	Always	ABS	0	0
AL1	ALARM SIGNAL1	0 ~ 12	Always	ABS	0	0
AL2	ALARM SIGNAL2	0 ~ 12	Always	ABS	0	0
AL3	ALARM SIGNAL3	0 ~ 12	Always	ABS	0	0
AL4	ALARM SIGNAL4	0 ~ 12	Always	ABS	0	0
S.AL1	SEG ALARM SIGNAL1	0 ~ 12	Always	ABS	0	0
S.AL2	SEG ALARM SIGNAL2	0 ~ 12	Always	ABS	0	0
S.AL3	SEG ALARM SIGNAL3	0 ~ 12	Always	ABS	0	0
S.AL4	SEG ALARM SIGNAL4	0 ~ 12	Always	ABS	0	0
ERR	ERROR	0 ~ 12	Always	ABS	0	0
RELAY	RELAY	0 ~ 8	Always	ABS	0	0
T1	T1 SIGNAL	0 ~ 12	Always	ABS	0	0
T1 PARA	T1 SIGNAL PARA	0.00~99.59 MM,SS	Always	ABS	00.00	0
T2	T2 SIGNAL	0 ~ 12	Always	ABS	0	0
T2 PARA	T2 SIGNAL PARA	0.00~99.59 MM,SS	Always	ABS	00.00	0
T3	T3 SIGNAL	0 ~ 12	Always	ABS	0	0
T3 PARA	T3 SIGNAL PARA	0.00~99.59 MM,SS	Always	ABS	00.00	0
T4	T4 SIGNAL	0 ~ 12	Always	ABS	0	0
T4 PARA	T4 SIGNAL PARA	0.00~99.59 MM,SS	Always	ABS	00.00	0
UP	UP SIGNAL	0 ~ 12	Always	ABS	0	0
UP PARA	UP PARAMETER	EUS(0,0~10,0%)	Always	EUS	EUS(0,0%)	0
SOAK	SOAK SIGNAL	0 ~ 12	Always	ABS	0	0
SOAK PARA	SOAK PARAMETER	0~999 (TMU)	Always	TIME	0 MIN	0
DOWN	DOWN SIGNAL	0 ~ 12	Always	ABS	0	0
DOWN PARA	DOWN PARAMETER	EUS(0,0~10,0%)	Always	EUS	EUS(0,0%)	0
PTEND	PTEND SIGNAL	0 ~ 12	Always	ABS	0	0
PTEND PARA	PTEND PARAMETER	0~999 SEC	Always	TIME	0 SEC	0
HOLD	HOLD SIGNAL	0 ~ 12	Always	ABS	0	0
HOLD PARA	HOLD PARAMETER	0~999 MIN	Always	TIME	0 MIN	0

4.5.7 PIECE BIAS SET

<table border="1"> <tr><td>SETUP MENU</td><td>12:54P</td></tr> <tr><td>INPUT DO</td><td>PTN SUB</td></tr> <tr><td>OUTPUT BIAS</td><td>SEG ALM</td></tr> <tr><td>RET DI</td><td>REPEAT</td></tr> <tr><td>INNER PWD</td><td>TIME SG</td></tr> <tr><td>ALARM FILE</td><td>ON/OFF</td></tr> </table>	SETUP MENU	12:54P	INPUT DO	PTN SUB	OUTPUT BIAS	SEG ALM	RET DI	REPEAT	INNER PWD	TIME SG	ALARM FILE	ON/OFF	SETUP MENU screen to enter BIAS SET. Operation screen will return by pushing SET KEY again for 3 sec. or NO KEY input for 60 sec.
SETUP MENU	12:54P												
INPUT DO	PTN SUB												
OUTPUT BIAS	SEG ALM												
RET DI	REPEAT												
INNER PWD	TIME SG												
ALARM FILE	ON/OFF												
<table border="1"> <tr><td>PIECE BIAS1</td><td>12:54P</td></tr> <tr><td>RL(P/D)</td><td>-50.00 0.00</td></tr> <tr><td>P1(P/D)</td><td>150.00 0.00</td></tr> <tr><td>P2(P/D)</td><td>150.00 0.00</td></tr> <tr><td>P3(P/D)</td><td>150.00 0.00</td></tr> <tr><td>P U</td><td>: 57.02c</td></tr> </table>	PIECE BIAS1	12:54P	RL(P/D)	-50.00 0.00	P1(P/D)	150.00 0.00	P2(P/D)	150.00 0.00	P3(P/D)	150.00 0.00	P U	: 57.02c	Set bias for piece RL(P), P1(P), P2(P), P3(P) : Point (Boundary point) RL(D), P1(D), P2(D), P3(D) : Bias value
PIECE BIAS1	12:54P												
RL(P/D)	-50.00 0.00												
P1(P/D)	150.00 0.00												
P2(P/D)	150.00 0.00												
P3(P/D)	150.00 0.00												
P U	: 57.02c												
<table border="1"> <tr><td>PIECE BIAS2</td><td>12:54P</td></tr> <tr><td>P4(P/D)</td><td>150.00 0.00</td></tr> <tr><td>P5(P/D)</td><td>150.00 0.00</td></tr> <tr><td>P6(P/D)</td><td>150.00 0.00</td></tr> <tr><td>P7(P/D)</td><td>150.00 0.00</td></tr> <tr><td>P U</td><td>: 57.02c</td></tr> </table>	PIECE BIAS2	12:54P	P4(P/D)	150.00 0.00	P5(P/D)	150.00 0.00	P6(P/D)	150.00 0.00	P7(P/D)	150.00 0.00	P U	: 57.02c	Set bias for piece P4(P), P5(P), P6(P), P7(P) : Point (Boundary point) P4(D), P5(D), P6(D), P7(D) : Bias value
PIECE BIAS2	12:54P												
P4(P/D)	150.00 0.00												
P5(P/D)	150.00 0.00												
P6(P/D)	150.00 0.00												
P7(P/D)	150.00 0.00												
P U	: 57.02c												
<table border="1"> <tr><td>PIECE BIAS3</td><td>12:54P</td></tr> <tr><td>P8(P/D)</td><td>150.00 0.00</td></tr> <tr><td>P9(P/D)</td><td>150.00 0.00</td></tr> <tr><td>RH(P/D)</td><td>150.00 0.00</td></tr> <tr><td>P U</td><td>: 57.02c</td></tr> </table>	PIECE BIAS3	12:54P	P8(P/D)	150.00 0.00	P9(P/D)	150.00 0.00	RH(P/D)	150.00 0.00	P U	: 57.02c	Set bias for piece P8(P), P9(P), RH(P) : Point (Boundary point) P8(D), P9(D), RH(D) : Bias value		
PIECE BIAS3	12:54P												
P8(P/D)	150.00 0.00												
P9(P/D)	150.00 0.00												
RH(P/D)	150.00 0.00												
P U	: 57.02c												

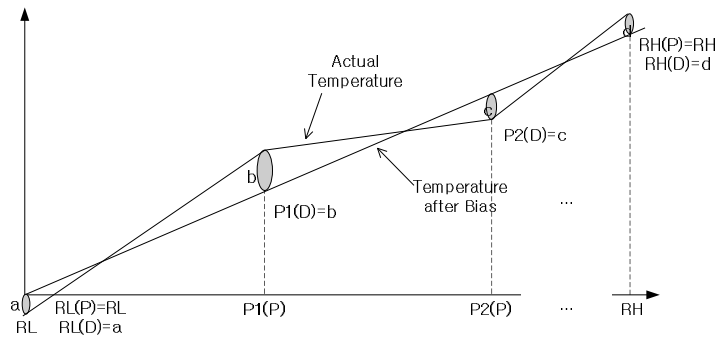

(Figure25 : Ex. Piece Bias Formula)

Symbol	Parameter	Range	Display	Unit	Default	Edit
RL(P)	REFERENCE BIAS RL	EU(0.0~100.0%) RL≤DP,RL≤DP,P1 ≤DP,P2≤DP,P3≤DP,P4	Always	EU	EU(0.0%)	X
P1(P)	REFERENCE BIAS POINT1		Always	EU	EU(100.0%)	O
P2(P)	REFERENCE BIAS POINT2		Always	EU	EU(100.0%)	O
P3(P)	REFERENCE BIAS POINT3		Always	EU	EU(100.0%)	O
RL(D)	BIAS VALUE OF RL	EUS(-10.0~10.0%)	Always	EUS	EUS(0.0%)	O
P1(D)	BIAS VAUE OF POINT1		Always	EUS	EUS(0.0%)	O
P2(D)	BIAS VALUE OF POINT2		Always	EUS	EUS(0.0%)	O
P3(D)	BIAS VALUE OF POINT3		Always	EUS	EUS(0.0%)	O
P4(P)	REFERENCE BIAS POINT4	EU(0.0~100.0%) DP,P3≤DP,P4≤DP,P5 ≤DP,P6≤DP,P7≤DP,P8	Always	EU	EU(100.0%)	O
P5(P)	REFERENCE BIAS POINT5		Always	EU	EU(100.0%)	O
P6(P)	REFERENCE BIAS POINT6		Always	EU	EU(100.0%)	O
P7(P)	REFERENCE BIAS POINT7		Always	EU	EU(100.0%)	O
P4(D)	BIAS VAUE OF POINT4	EUS(-10.0~10.0%)	Always	EUS	EUS(0.0%)	O
P5(D)	BIAS VALUE OF POINT5		Always	EUS	EUS(0.0%)	O
P6(D)	BIAS VALUE OF POINT6		Always	EUS	EUS(0.0%)	O
P7(D)	BIAS VALUE OF POINT7		Always	EUS	EUS(0.0%)	O
P8(P)	REFERENCE BIAS POINT8	EU(0.0~100.0%) DP,P7≤DP,P8≤DP,P9 ≤RH	Always	EU	EU(100.0%)	O
P9(P)	REFERENCE BIAS POINT9		Always	EU	EU(100.0%)	O
RH(P)	REFERENCE BIAS RH		Always	EU	EU(100.0%)	X
P8(D)	BIAS VAUE OF POINT8	EUS(-10.0~10.0%)	Always	EUS	EUS(0.0%)	O
P9(D)	BIAS VAUE OF POINT9		Always	EUS	EUS(0.0%)	O
RH(D)	BIAS VALUE OF RH		Always	EUS	EUS(0.0%)	O

4,5,8 Digital Input (DI) SET

<pre> SETUP MENU 12:54P INPUT DO PTH SUB OUTPUT BIAS SEG ALM RET DI REPEAT INNER PWD TIME SG ALARM FILE ON/OFF </pre>	<p>SETUP MENU screen to enter DI SET. Operation screen will return by pushing SET KEY again for 3 sec. or NO KEY input for 60 sec.</p>
---	--

<pre> DI OPERATION 12:54P DI SL:0 STS:0000 DI1 :RUN DI2:STOP DI3 :ERROR_01_ DI4 :ERROR_02_ TOG GROUP:ABCD </pre>	<p>DI SL : This parameter determines the operation mode of Digital Input external relay contact. The Digital Input operating configurations are shown in TABLE3 : DI Operation. STS : This parameter will display '1'(ON) when Digital Input activates. Its default value is '0'(OFF) DI3, DI4 : Error name on DI3 and DI4 can be defined by user (SET KEY → UP or DOWN)</p>
--	--

Symbol	Parameter	Range	Display	Unit	Default	Edit
DI SL	DI SELECT	0, 1	FIX MODE	ABS	0	O
		0, 1, 2, 3	PROG MODE	ABS	0	O
STS	DI STATUS	0000~1111	상시표시	ABS	0000	X
DI1 NAME	DI1 NAME	RUN	Always	ABS	RUN	X
DI2 NAME	DI2 NAME	STOP	Always	ABS	STOP	X
DI3 NAME	DI3 NAME	0 ~ 9, A ~ Z, Symbols	Always	ABS	ERROR 03	O
DI4 NAME	DI4 NAME	0 ~ 9, A ~ Z, Symbols	Always	ABS	ERROR 04	O
TOG GROUP	TOG GROUP	A ~ Z, 0 ~ 9, Symbols	Always	ABS	ABCD	X

TABLE 3 : DI Operation

Symbol	DI1	DI2	DI3	DI4	Operation	
F I X	0	ON	OFF	OFF	OFF	RUN
		OFF	ON	OFF	OFF	STOP
		-	-	ON	OFF	ERROR 1
		-	-	OFF	ON	ERROR 2
	1	ON	OFF	-	-	RUN
		OFF	ON	-	-	STOP
		-	-	OFF	OFF	SP1
		-	-	ON	OFF	SP2
		-	-	OFF	ON	SP3
		-	-	ON	ON	SP4
P R O G	0	ON	OFF	OFF	OFF	RUN
		OFF	ON	OFF	OFF	STOP
		-	-	ON	OFF	ERROR 1
		-	-	OFF	ON	ERROR 2
	1	OFF	OFF	OFF	OFF	PT manual
		ON	OFF	OFF	OFF	PT1
		OFF	ON	OFF	OFF	PT2
		ON	ON	OFF	OFF	PT3
		OFF	OFF	ON	OFF	PT4
		ON	OFF	ON	OFF	PT5
		OFF	ON	ON	OFF	PT6
		ON	ON	ON	OFF	PT7
		OFF	OFF	OFF	ON	PT8
		ON	OFF	OFF	ON	PT9
		OFF	ON	OFF	ON	PT10
		ON	ON	OFF	ON	PT11
		OFF	OFF	ON	ON	PT12
		ON	OFF	ON	ON	PT13
		OFF	ON	ON	ON	PT14
	ON	ON	ON	ON	PT15	
	2	ON	OFF	-	-	RUN
		OFF	ON	-	-	STOP
		-	-	ON	-	HOLD ON
		-	-	OFF	-	HOLD OFF
		-	-	-	ON	STEP ON
	3	ON	-	-	-	RUN
		OFF	-	-	-	STOP
		-	OFF	OFF	OFF	PT manual
		-	ON	OFF	OFF	PT1
		-	OFF	ON	OFF	PT2
-		ON	ON	OFF	PT3	
-		OFF	OFF	ON	PT4	
-		ON	OFF	ON	PT5	
-	OFF	ON	ON	PT6		
-	ON	ON	ON	PT7		

4.5.9 PASSWORD SET

SETUP MENU 12:54P INPUT DO PTN SUB OUTPUT BIAS SEG ALM RET DI REPEAT INNER PWD TIME SG ALARM FILE ON/OFF	SETUP MENU screen to enter PASSWORD SET. Operation screen will return by pushing SET KEY again for 3 sec, or NO KEY input for 60 sec.
---	--

PASSWORD 12:54P PASS: 0	Set the new password SET KEY → UP, DOWN, SHIFT key → SET KEY
----------------------------	---



Default password is 0.(ZERO)
 After changing password, please confirm your new password.
 ▶ If you forget the password, connect Samwontech or our agency for reset service
 All of the data that you set before will be changed to default after reset.

Symbol	Parameter	Range	Display	Unit	Default	EDIT
PASS	PASSWORD SETTING	0000 ~ 9999	Always	ABS	0000	0

4.5.10 FILE EDIT

<pre> SETUP MENU 12:54P INPUT DO PTN SUB OUTPUT BIAS SEG ALM RET DI REPEAT INNER PWD TIME SG ALARM FILE ON/OFF </pre>	SETUP MENU screen to enter FILE EDIT SET. Operation screen will return by pushing SET KEY again for 3 sec, or NO KEY input for 60 sec.
---	---

<pre> FILE EDIT 12:54P SRC PT NO : 0 DES PT NO : 0 EXE : 0 DEL PT NO : 0 DEL : 0 PT ALL CLR CLR : 0 RESULT : EXE DONE </pre>	SRC PT NO : Number of PATTERN for copy DES : Number of PATTERN to copy EXE : Operate when fixed to 1 DEL PT NO : Number of PATTERN for delete DEL : Deleted when fixed to 1 PT ALL CLR : All patterns are cleared when fixed to 1
--	--

Symbol	Parameter	Range	Display	Unit	Default	EDIT
SRC PT NO	Source Pattern Number	0 ~ 30	Always	ABS	0	○
DES PT NO	Destination Pattern Number	0 ~ 30	Always	ABS	0	○
EXE	EXECUTE	0, 1	Always	ABS	0	○
DEL PT NO	DELETE PATTERN NUMBER	0 ~ 30	Always	ABS	0	○
DEL	DELETE	0, 1	Always	ABS	0	○
PT ALL CLR	PATTERN ALL CLEAR	0, 1	Always	ABS	0	○
RESULT	RESULT	PARA ERR, EXE DONE, PT EMPTY, NO SEG, PT USING	Always	ABS	×	×

4.5.11 PTN SUB

<pre> SETUP MENU 12:54P INPUT DO PTN SUB OUTPUT BIAS SEG ALM RET DI REPEAT INNER PWD TIME SG ALARM FILE ON/OFF </pre>	<p>SETUP MENU screen to enter PTN SUB SET. Operation screen will return by pushing SET KEY again for 3 sec, or NO KEY input for 60 sec.</p>
<pre> PTN SUB SET 12:54P PT NO : 30 </pre>	<p>PT NO : Set the PATTERN No.,</p>
<pre> SG PID S.ALMI 2 3 4 001 0 0 0 0 0 002 0 0 0 0 0 003 0 0 0 0 0 004 0 0 0 0 0 005 0 0 0 0 0 </pre>	<p>Set PID NO. SEG ALARM 1, 2, 3, 4 of each SEG (when PID NO=0, ZONE PID work)</p>

Symbol	Parameter	Range	Display	Unit	Default	EDIT
PTNO	PATTERN NUMBER	1 ~ 30	Always	ABS	0	○
PID	PID NUMBER	0~4	Always	ABS	0	○
S,ALM1	SEG ALARM 1	0~8	Always	ABS	0	○
S,ALM2	SEG ALARM 2	0~8	Always	ABS	0	○
S,ALM3	SEG ALARM 3	0~8	Always	ABS	0	○
S,ALM4	SEG ALARM 4	0~8	Always	ABS	0	○

4.5.12 SEG ALM

SETUP MENU 12:54P INPUT DO PTN SUB OUTPUT BIAS SEG ALM RET DI REPEAT INNER PWD TIME SG ALARM FILE ON/OFF	SETUP MENU screen to enter SEG ALM SET. Operation screen will return by pushing SET KEY again for 3 sec. or NO KEY input for 60 sec.
--	---

S.ALM SIGNAL1 12:54P KIND : AH.F POINT : 150.00 % HYS : 1.00 % DELAY.TM : 00.00 M.S	KIND : Set type of ALARM POINT : Set the value of ALARM HYS : Set HYSTERESIS for ALARM DELAY.TM : Set the delay time for ALARM output SEG ALARM SIGNAL1~8 screen. ALARM on PTN SUB will works only when PROG RUN
--	---

Symbol	Parameter	Range	Display	Unit	Default	EDIT
KIND	ALARM KIND	OFF, AH.F, AL.F, DH.F, DLF	Always	ABS	AH.F	O
		DH.R, DLR, DO.F, DLF, AH.R				
		AL.R, AH.FS, ALFS, DH.FS				
		DLFS, DH.RS, DLRS				
		DO.FS, DLFS, AH.RS, ALRS				
POINT	ALARM POINT	EUS(-100,0~100,0%)	PV Upper-Limit	EU	EUS(100,0%)	O
			PV Lower-Limit	EU	EUS(0,0%)	O
HIGH DEV.	HIGH DEVIATION	EUS(-100,0%)~EUS(100,0%)	Deviation	EUS	EUS(100,0%)	O
LOW DEV.	LOW DEVIATION	EUS(-100,0%)~EUS(100,0%)	Deviation	EUS	EUS(0,0%)	O
HYS	ALARM HYSTERESIS	EUS(0,0~100,0%)	Always	EUS	EUS(0,5%)	O
DELAY.TM	DELAY TIME	00,00~99,59 MM,SS	Always	TIME	00,00 MM,SS	O

4.5.13 REPEAT

<pre> SETUP MENU 12:54P INPUT DO PTN SUB OUTPUT BIAS SEG ALM RET DI REPEAT INNER PWD TIME SG ALARM FILE ON/OFF </pre>	<p>SETUP MENU screen to enter REPEAT SET. Operation screen will return by pushing SET KEY again for 3 sec. or NO KEY input for 60 sec.</p>
<pre> PATTERN RPT 12:54P PT NO : 30 LINK PT : 0 PT RPT : 1 PT E.MODE : RESET </pre>	<p>Set the repeat (number of time) and link pattern, PT E.MODE: It is decide PROG MODE in case of PATTERN END. - RESET : PT END, - HOLD : HOLD in last SEG SP - FIX : FIX RUN after PATTERN END - LINK : Running as Pattern to set into LINK PATTERN after PATTERN END</p>
<pre> SEGMENT RPT 12:54P NO S.SEG E.SEG R.CNT 1 0 0 0 2 0 0 0 3 0 0 0 4 0 0 0 </pre>	<p>Set the repeat (number of time) and segment of the top/end.</p>

Symbol	Parameter	Range	Display	Unit	Default	EDIT
PTNO	PATTERN NUMBER	1 ~ 30	Always	ABS	1	○
LINK PT	LINK PATTERN	0 ~ 30	Always	ABS	0	○
PT RPT	PATTERN RPT NO	0 ~ 999	Always	ABS	1	○
PT E.MODE	PATTERN END MODE	RESET, HOLD, FIX, LINK	Always	ABS	RESET	○
NO	REPEAT NUMBER	1 ~ 4	Always	ABS	×	×
S.SEG	START SEGMENT	0 ~ 100	Always	ABS	0	○
E.SEG	END SEGMENT	0 ~ 100	Always	ABS	0	○
R.CNT	REPEAT COUNT	0 ~ 99	Always	ABS	0	○

4.5.14 TIME SIGNAL

<table border="1"> <tr> <td>SETUP MENU</td> <td>12:54P</td> </tr> <tr> <td>INPUT DO</td> <td>PTN SUB</td> </tr> <tr> <td>OUTPUT BIAS</td> <td>SEG ALM</td> </tr> <tr> <td>RET DI</td> <td>REPEAT</td> </tr> <tr> <td>INNER PWD</td> <td>TIME SG</td> </tr> <tr> <td>ALARM FILE</td> <td>ON/OFF</td> </tr> </table>	SETUP MENU	12:54P	INPUT DO	PTN SUB	OUTPUT BIAS	SEG ALM	RET DI	REPEAT	INNER PWD	TIME SG	ALARM FILE	ON/OFF	SETUP MENU screen to enter PTN SUB SET. Operation screen will return by pushing SET KEY again for 3 sec. or NO KEY input for 60 sec.
SETUP MENU	12:54P												
INPUT DO	PTN SUB												
OUTPUT BIAS	SEG ALM												
RET DI	REPEAT												
INNER PWD	TIME SG												
ALARM FILE	ON/OFF												

<table border="1"> <tr> <td>NO</td> <td>ON.TM</td> <td>OFF.TM</td> </tr> <tr> <td>0</td> <td>TS OFF</td> <td>TS OFF</td> </tr> <tr> <td>1</td> <td>TS ON</td> <td>TS ON</td> </tr> <tr> <td>2</td> <td>00.00</td> <td>00.00</td> </tr> <tr> <td>3</td> <td>00.00</td> <td>00.00</td> </tr> <tr> <td>4</td> <td>00.00</td> <td>00.00</td> </tr> </table>	NO	ON.TM	OFF.TM	0	TS OFF	TS OFF	1	TS ON	TS ON	2	00.00	00.00	3	00.00	00.00	4	00.00	00.00	EDIT TIME SIGNAL set NO, 0,1 means the state of time signal when it is both OFF and ON, and For NO,2~9, fix time to ON and OFF. In this screen, designate the occurrence of ON/OFF on Time Signal, and designate on EDIT SEG of "MAIN MENU → PROGRAM → PATTERN" to output.
NO	ON.TM	OFF.TM																	
0	TS OFF	TS OFF																	
1	TS ON	TS ON																	
2	00.00	00.00																	
3	00.00	00.00																	
4	00.00	00.00																	

Symbol	Parameter	Range	Display	Unit	Default	EDIT
ON.TM	ON TIME	00,00~99,59 (TMU)	Always	TIME	00,00 H,M	○
OFF.TM	OFF TIME	00,00~99,59 (TMU)	Always	TIME	00,00 H,M	○

4.5.15 ON/OFF SET

<table border="1"> <tr> <td>SETUP MENU</td> <td>12:54P</td> </tr> <tr> <td>INPUT DO</td> <td>PTN SUB</td> </tr> <tr> <td>OUTPUT BIAS</td> <td>SEG ALM</td> </tr> <tr> <td>RET DI</td> <td>REPEAT</td> </tr> <tr> <td>INNER PWD</td> <td>TIME SG</td> </tr> <tr> <td>ALARM FILE</td> <td>ON/OFF</td> </tr> </table>	SETUP MENU	12:54P	INPUT DO	PTN SUB	OUTPUT BIAS	SEG ALM	RET DI	REPEAT	INNER PWD	TIME SG	ALARM FILE	ON/OFF	SETUP MENU screen to enter ON/OFF SET. Operation screen will return by pushing SET KEY again for 3 sec, or NO KEY input for 60 sec.
SETUP MENU	12:54P												
INPUT DO	PTN SUB												
OUTPUT BIAS	SEG ALM												
RET DI	REPEAT												
INNER PWD	TIME SG												
ALARM FILE	ON/OFF												
<table border="1"> <tr> <td>ON/OFF T1</td> <td>12:54P</td> </tr> <tr> <td>HIGH.SP :</td> <td>-50.0 c</td> </tr> <tr> <td>MIDDLE.SP :</td> <td>-50.0 c</td> </tr> <tr> <td>LOW.SP :</td> <td>-50.0 c</td> </tr> <tr> <td>HIGH.DIFF :</td> <td>0.0 c</td> </tr> <tr> <td>LOW.DIFF :</td> <td>0.0 c</td> </tr> </table>	ON/OFF T1	12:54P	HIGH.SP :	-50.0 c	MIDDLE.SP :	-50.0 c	LOW.SP :	-50.0 c	HIGH.DIFF :	0.0 c	LOW.DIFF :	0.0 c	This is ON/OFF T1 MODE screen. HIGH.SP : Set HIGH SP when ON/OFF mode, HIGH.DIFF : Set operating POINT on HIGH zone. MIDDLE.SP : Set MIDDLE SP when ON/OFF mode. LOW.SP : Set LOW SP when ON/OFF mode., LOW.DIFF : Set operating POINT on LOW zone,.
ON/OFF T1	12:54P												
HIGH.SP :	-50.0 c												
MIDDLE.SP :	-50.0 c												
LOW.SP :	-50.0 c												
HIGH.DIFF :	0.0 c												
LOW.DIFF :	0.0 c												
<table border="1"> <tr> <td>ON/OFF T2</td> <td>12:54P</td> </tr> <tr> <td>HIGH.SP :</td> <td>-50.0 c</td> </tr> <tr> <td>MIDDLE.SP :</td> <td>-50.0 c</td> </tr> <tr> <td>LOW.SP :</td> <td>-50.0 c</td> </tr> <tr> <td>HIGH.DIFF :</td> <td>0.0 c</td> </tr> <tr> <td>LOW.DIFF :</td> <td>0.0 c</td> </tr> </table>	ON/OFF T2	12:54P	HIGH.SP :	-50.0 c	MIDDLE.SP :	-50.0 c	LOW.SP :	-50.0 c	HIGH.DIFF :	0.0 c	LOW.DIFF :	0.0 c	This is ON/OFF T2 MODE screen. HIGH.SP : Set HIGH SP when ON/OFF mode. HIGH.DIFF : Set operating POINT on HIGH zone. MIDDLE.SP : Set MIDDLE SP when ON/OFF mode., LOW.SP : Set LOW SP when ON/OFF mode., LOW.DIFF : Set operating POINT on LOW zone,.
ON/OFF T2	12:54P												
HIGH.SP :	-50.0 c												
MIDDLE.SP :	-50.0 c												
LOW.SP :	-50.0 c												
HIGH.DIFF :	0.0 c												
LOW.DIFF :	0.0 c												
<table border="1"> <tr> <td>ON/OFF T3</td> <td>12:54P</td> </tr> <tr> <td>HIGH.SP :</td> <td>-50.0 c</td> </tr> <tr> <td>MIDDLE.SP :</td> <td>-50.0 c</td> </tr> <tr> <td>LOW.SP :</td> <td>-50.0 c</td> </tr> <tr> <td>HIGH.DIFF :</td> <td>0.0 c</td> </tr> <tr> <td>LOW.DIFF :</td> <td>0.0 c</td> </tr> </table>	ON/OFF T3	12:54P	HIGH.SP :	-50.0 c	MIDDLE.SP :	-50.0 c	LOW.SP :	-50.0 c	HIGH.DIFF :	0.0 c	LOW.DIFF :	0.0 c	This is ON/OFF T3 MODE screen. HIGH.SP : Set HIGH SP when ON/OFF mode. HIGH.DIFF : Set operating POINT on HIGH zone. MIDDLE.SP : Set MIDDLE SP when ON/OFF mode., LOW.SP : Set LOW SP when ON/OFF mode., LOW.DIFF : Set operating POINT on LOW zone,.
ON/OFF T3	12:54P												
HIGH.SP :	-50.0 c												
MIDDLE.SP :	-50.0 c												
LOW.SP :	-50.0 c												
HIGH.DIFF :	0.0 c												
LOW.DIFF :	0.0 c												
<table border="1"> <tr> <td>ON/OFF T4</td> <td>12:54P</td> </tr> <tr> <td>HIGH.SP :</td> <td>-50.00 c</td> </tr> <tr> <td>MIDDLE.SP :</td> <td>-50.00 c</td> </tr> <tr> <td>LOW.SP :</td> <td>-50.00 c</td> </tr> <tr> <td>HIGH.DIFF :</td> <td>0.00 c</td> </tr> <tr> <td>LOW.DIFF :</td> <td>0.00 c</td> </tr> </table>	ON/OFF T4	12:54P	HIGH.SP :	-50.00 c	MIDDLE.SP :	-50.00 c	LOW.SP :	-50.00 c	HIGH.DIFF :	0.00 c	LOW.DIFF :	0.00 c	This is ON/OFF T4 MODE screen. HIGH.SP : Set HIGH SP when ON/OFF mode. HIGH.DIFF : Set operating POINT on HIGH zone. MIDDLE.SP : Set MIDDLE SP when ON/OFF mode., LOW.SP : Set LOW SP when ON/OFF mode., LOW.DIFF : Set operating POINT on LOW zone,.
ON/OFF T4	12:54P												
HIGH.SP :	-50.00 c												
MIDDLE.SP :	-50.00 c												
LOW.SP :	-50.00 c												
HIGH.DIFF :	0.00 c												
LOW.DIFF :	0.00 c												



It has to be kept the order HIGH first,

Symbol	Parameter	Range	Display	Unit	Default	EDIT
HIGH.SP	HIGH SP	EU(0,0~100,0%)	Always	EU	EU(0,0%)	0
MIDDLE.SP	MIDDLE SP	RL≤LOW.SP <MIDDLE.SP	Always	EU	EU(0,0%)	0
LOW.SP	LOW SP	<HIGH.SP≤RH	Always	EU	EU(0,0%)	0
HIGH.DIFF	HIGH DIFFERENCE	EUS(0,0 ~ 10,0%)	Always	EUS	EUS(0,0%)	0
LOW.DIFF	LOW DIFFERENCE	EUS(0,0 ~ 10,0%)	Always	EUS	EUS(0,0%)	0

1. T1~T4 (TS will be ON after set time, Set time will be applied only first ON of RUN)

- ① $NPV < LSP(LOW.SP) \rightarrow$ OUTPUT OFF
- ② $NPV > HSP(HIGH.SP) \rightarrow$ OUTPUT OFF
- ③ $LSP \leq NPV < MSP(MIDDLE.SP)$
 $NPV \geq NSP-LD(LOW.DIFF) \rightarrow$ OUTPUT ON
 $NPV < NSP-LD \rightarrow$ OUTPUT OFF
- ④ $MSP < NPV < HSP$
 $NPV < NSP+HD(HIGH.DIFF) \rightarrow$ OUTPUT OFF
 $NPV \geq NSP+HD \rightarrow$ OUTPUT ON

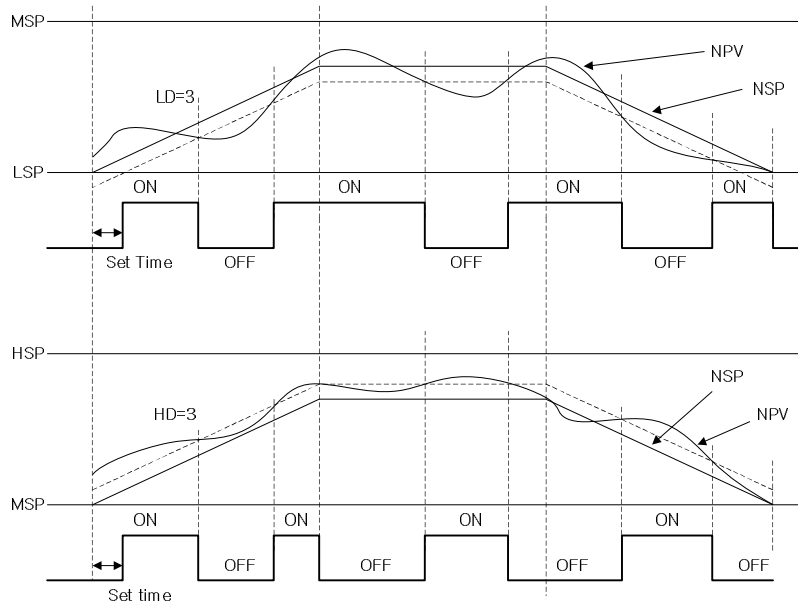

(Figure 26 : Ex of ON/OFF MODE Operation)

4.6 TROUBLE SHOOTING

TROUBLE	12:54P	If the system, which this controller (SP790) adapted, has troubles (if you used DB~DI4), the page appear also display WARN at the item state as picture. You must solve the error before reusing the controller, otherwise you are reach error again. The controller is being the STOP mode automatically when error occur.
ERROR 01 :	OK	
ERROR 02 :	WARN	
OCCUR TIME: 12:54P		

 NOTE Ref 4,5,8 DI NAME for change TROUBLE(DI ERROR) NAME

※ RESET Operation on TROUBLE screen, when DI ERROR occurs.

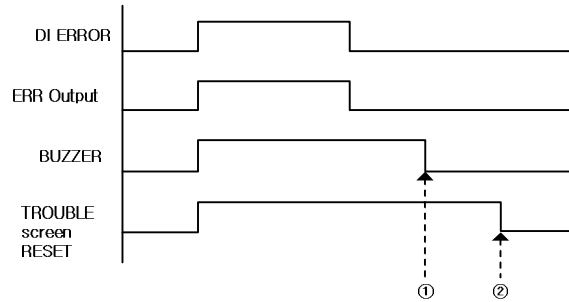

- ① BUZZER STOP by SET KEY
- ② TROUBLE screen will be RESET by other KEY except for SET KEY.

5. Installation

5.1 Dimension & Panel Cutting Size

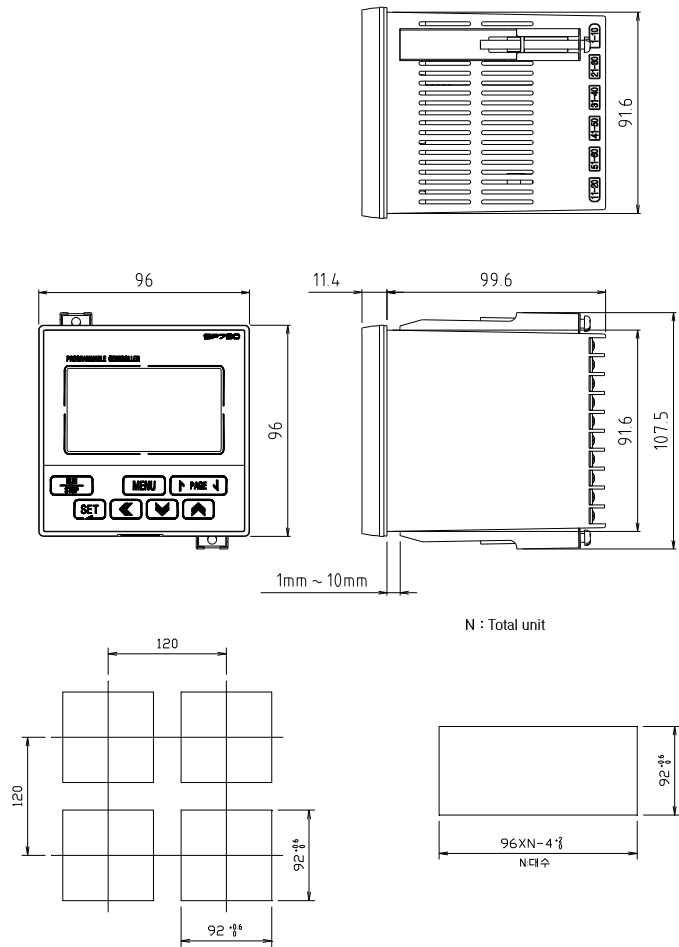

5.2 How to install Mount

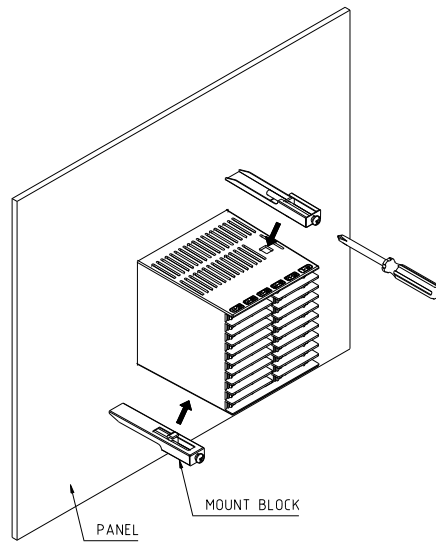

- 1) Cut the mounting panel as Section 5.1 PANEL CUTTING.
- 2) Insert the unit from its back terminal board side.
- 3) Attach the left and right brackets to the unit to fix the unit to the mounting panel. (Use screwdriver)



Do not tighten the mounting screw excessively, or the unit case or bracket may be damaged.

5.3 Power Cable Specification

Applicable power source cable : Vinyl insulation cable KSC 3304 0,9~2,0 mm².

5.4 Terminal Specification

Please use-tightening torque with insulating sleeve for M3,5 screws as shown in the following Figure:

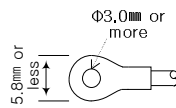

Note: When the screw is connected, its torque does not exceed 0,8 N·m.



CAUTION

- ▶ Before carrying out wiring, turn off the power to the controller and check that the cables to be connected are not alive with a tester or the like because there is a possibility of electric shock.
- ▶ The controller must be wired directly from circuit breaker output on inside of temperature & humidity Chamber for avoid damage of controller or chamber.



Avoid unused terminal for install, it might make damage to system or out of order.

5.5 Terminal Arrangement and External Wiring

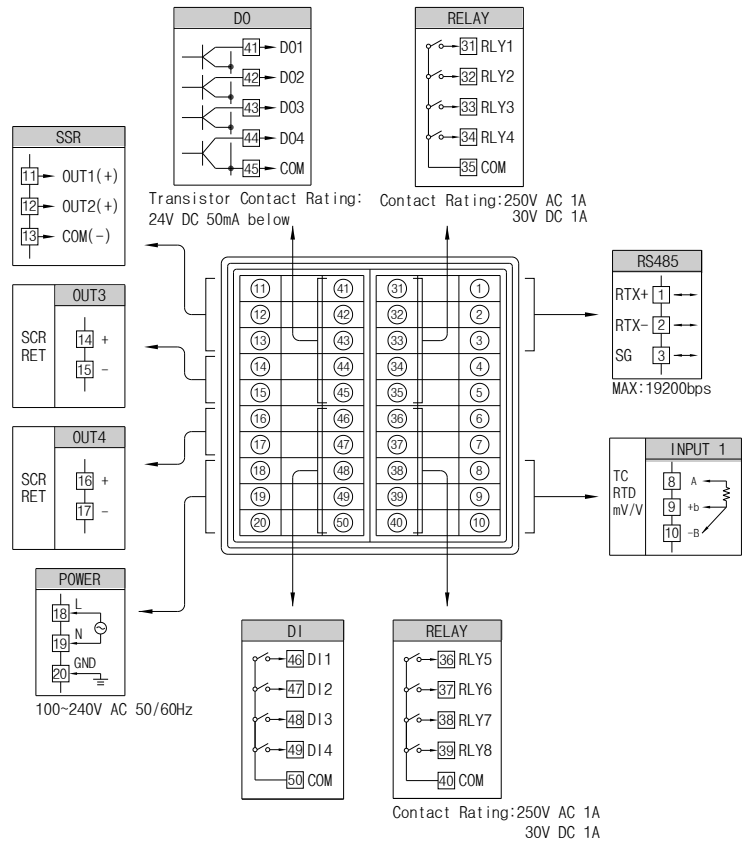

5.6 Grounding and Power Cable Connection

- Use a cable 2 mm² or more thick for grounding with class 3 grounding (grounding resistance a 100Ω or less) or higher. Do not extend the grounding cable over 20m.
- Ground from the ground terminal with a one-point contact
Do not wire between ground terminals.
- Use appropriate cables equivalent to vinyl insulation cable(KSC 3304) or more.

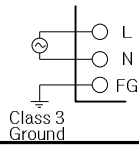

- ▶ Ground FRAME GROUND (FG) exactly
- ▶ For power source wiring, keep the L, N correctly otherwise it might make damage to system or broken the controller.



Before starting analog input wiring, be sure to turn off the system otherwise you might get an electrical shock



- ▶ When connection, do not mix up the input polarity.
- ▶ Connecting with the wrong polarity can cause the unit to malfunction.
- ▶ For input wiring, use a shielded cable.
- ▶ Ground the shield at one point and grounding circuits as possible.
- ▶ Sensor input line must have avoid power source cable for protect noise.
- ▶ Use the cable that does not have any resistance difference and cable resistance.

5.7 Analog Input Connection

(A) RTD INPUT

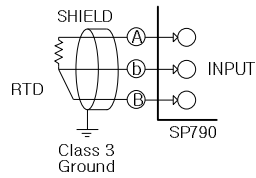

(B) DC VOLTAGE INPUT

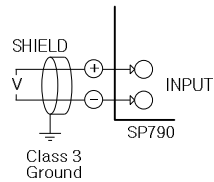

(C) DC CURRENT INPUT

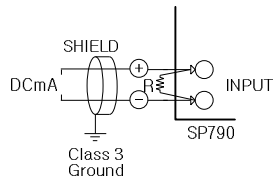

5.8 Analog Output Connection



Before starting analog output wiring, be sure to turn off the system or else you will get an electrical shock.



- ▶ When connection, do not mix up the input polarity.
- ▶ Connecting with the wrong polarity can cause the unit to malfunction.
- ▶ For input wiring, use a shielded cable.
- ▶ Ground the shield at one point and grounding circuits as possible.

(A) SSR

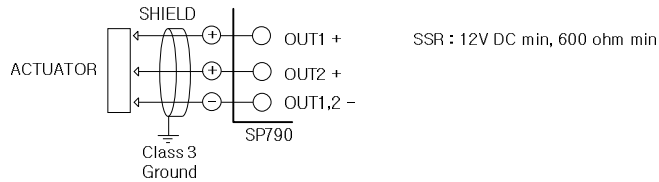

Before starting ACTUATOR install/uninstall wiring, be sure to turn off the SP790 or else you will get an electrical shock.

(B) RETRANSMISSION

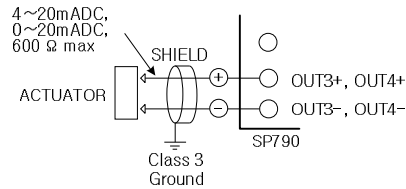

(C) RET

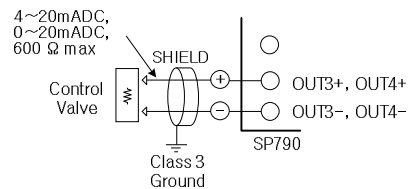

Before starting ACTUATOR install/uninstall wiring, be sure to turn off the SP790 or else you will get an electrical shock.

5.9 External Contact Output Connection (RELAY)

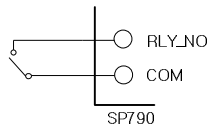

Before starting analog input wiring, be sure to turn off the system otherwise you might get an electrical shock.

5.10 External Contact Output Connection(OPEN COLLECTOR : DO)

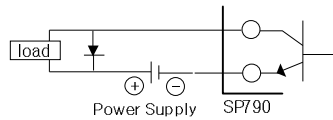

24V DC 50mA or less

5.11 External Contact Input Connection (DI)

- ▶ For the external contact, use a no-voltage contact (including relay contact) that can operate appropriately under the terminal voltage for a close contact (approximate, . 5V) and the current for a opened contact. (approximate 1mA)
- ▶ When using an open collector, select one with the 2V or less voltage for the closed contact, and 100μA or less leakage current for the open contact.

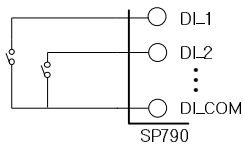

▲ RELAY contact input

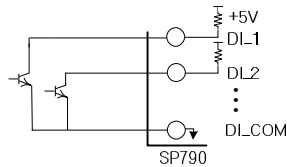

▲ TRANSISTOR contact input



Before starting analog input wiring, be sure to turn off the system otherwise you might get an electrical shock.

5.12 Use an Auxiliary Relay

■ If you INDUCTANCE(L) load like as AUXILIARY RELAY or SOLENOIDE VALVE, it might make go to wrong or out of order relay, please make sure insert to parallel circuit with CR FILTER(AC) or DIODE(DC) by SURGE SUPPRESSOR of avoiding sparks.

- Recommend CR FILTER
- ▶ Sung Ho Electronics : BSE104R120 25V (0.1 μ +120 Ω)
- ▶ Hana Parts Co. : HN2EAC
- ▶ Songmi Electric Co., Ltd. : CR UNIT 953, 955 etc
- ▶ Jiwol Electric Co., Ltd. : SKV, SKVB etc
- ▶ Shinyoung Communication Co., Ltd. : CR-CFS, CR-U etc

 If contact capacity is over owns specification, use auxiliary relay for ON/OFF load.
CAUTION

(A) DC RELAY

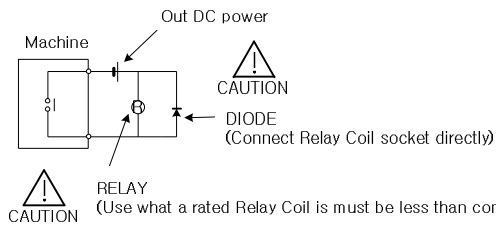

(B) AC RELAY

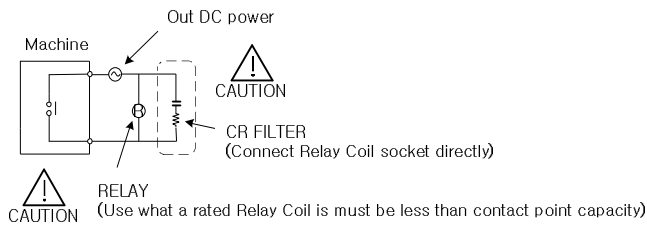

1. Communication Overview

SP790 communication is made by 2 lines way of half-duplex way by RS485, and as for communication with upper computer including PC, it is possible to connect up to maximum 31 numbers by Protocol prepared in advance.

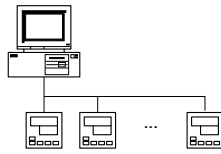

As below, there are some parameters when the SP790 communicates.

Parameter	Value	Description
PROTOCOL	0	Basic Protocol
	1	Basic Protocol + Check Sum
	2	MODBUS ASCII
	3	MODBUS RTU
	4	SYNC MASTER
TRANSMISSION RATE(BPS)	5	19200 bps
	4	9600 bps
	3	4800 bps
	2	2400 bps
	1	1200 bps
PARITY	0	None Parity
	1	Even Parity
	2	Odd Parity
DATA LENGTH	8	8 bits
	7	7 bits
ADDRESS	1 ~ 99	Address
RESPONSE TIME	0 ~ 10	Processing time + Response*10msec

■ Default parameter of communication

- PROTOCOL : 1(Basic Protocol + Check Sum)
- BPS : 4(9600 bps)
- PARITY : 0(None Parity)
- DATA LENGTH : 8(8 bits)
- ADDRESS : 1
- RESPONSE : 0(Processing time + 10 msec)

2. Wiring for Communication

SP790 communication terminal arrangement is as below.

2.1 RS485 Interface Connection with SP790

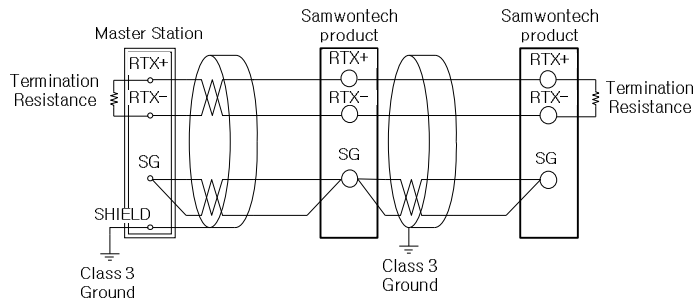

- The slave SP790 could be connected up to 31set. (MULTIDROP)
- Termination (200Ω 1/4W) resistance must be connected on the both part of edge.



Before starting analog input wiring, be sure to turn off the system otherwise you might get an electrical shock.

3. Configuration of Command

3.1 Consist of Command

It is basic communication command structure between upper-level computer and SP790

①	②	③	④	⑤	⑥	⑦	⑧
S T X	ADDRESS	COMMAND	,	DATA by COMMAND	SUM	C R	L F

① Command start of text

This code indicates the start of a command string with 0x02.

② ADDRESS

SP790 communication address to identify the instruments.

③ COMMAND

Specify the command from an upper device. (See 3.2~3.9)

④ ',' (Separation character)

Character for separating command and data by ','

⑤ Data

Data by Command rule

⑥ Check Sum

Display bottom 2-byte by Hexadecimal what the Sum with Ascii code from the next character of STX to the before character of SUM and only used when the PROTOCOL is type 1 + Check Sum on the SP790.

⑦, ⑧ CR, LF

This control code indicates the end of a command.

3.2 Type of Command

There are two kinds of commands, Self-information and Read/Write commands in the SP790.

① Self-information command

COMMAND	Process
AMI	Model name & Version

② Read/Write Command

COMMAND	Process
RSD	Reading D-Register orderly
RRD	Reading D-Register Random
WSD	Writing D-Register orderly
WRD	Writing D-Register Random
STD	Registration Random data of D-Register
CLD	Call D-Register of STD

Each command can read/write up to 32 D-Register and the all of the STD/CLD data will be reset when the power off, so the data should be resisted again,

3.3 Error Response

The message when the communication error with SP790.

Byte	1	2	2	2	2	1	1
Command element	S T X	Address	NG	Number of word(2)	SUM	C R	L F

※ SUM is only using when the PROTOCOL is '1'

3.4 RSD Command

This command for reading D-Register orderly.

■ Transmission Format

Byte	1	2	3	1	2	1	4	2	1	1
Command element	S	Addr	RSD	,	Parameter Number	,	D-Reg.NO,	SUM	C	L
	T								R	F
	X									

■ Response

Byte	1	2	3	1	2	1	4	1	4	1	...
Command element	S	Addr	RSD	,	OK	,	ddd-1	,	ddd-2	,	...
	T										
	X										

1	4	1	4	2	1	1
,	ddd-(n-1)	,	ddd-(n)	SUM	C	L
					R	F

- Parameter number : 1 ~ 32
- dddd : Indicates a character string in hexadecimal format

Ex) When reading the D-Register from Temp PV(D0001) to Temp SP(D0002)

- Transmission : [stx]01RSD,02,0001[cr] [lf]
- Transmission (Include Check Sum) : [stx]01RSD,02,0001C5[cr] [lf]
- ([stx] = 0x02, [cr] = 0x0d, [lf] = 0x0a)

Ex) The receiving data value are PV=50,0, SP=30,0, these data is receiving as blows,

- Transmission : [stx]01RSD,OK,01F4,012C[cr] [lf]
- Transmission (Include Check Sum) : [stx]01RSD,OK,01F4,012C19[cr] [lf]

※How to display and convert for receiving hexadecimal format PV data

- ① Convert decimal format : 01F4 (hexadecimal format) → 500 (decimal format)
- ② Result X 0,1 : 500 * 0,1 → 50,0

3.5 RRD Command

This command for reading D-Register random.

■ Transmission Format

Byte	1	2	3	1	2	1	4	1	4	1	...
Command element	S	Addr	RRD	,	Parameter Number	,	D-Reg.No1	,	D-Reg.No2	,	...
X											

1	4	1	4	2	1	1
,	D-Reg.No(n-1)	,	D-Reg.No(n)	SUM	C	L
					R	F

■ Response

Byte	1	2	3	1	2	1	4	1	4	1	...
Command element	S	Addr	RRD	,	OK	,	dddd-1	,	dddd-2	,	...
X											

1	4	1	4	2	1	1
,	dddd-(n-1)	,	dddd-(n)	SUM	C	L
					R	F

- Parameter number : 1 ~ 32

- dddd : Indicates a character string in hexadecimal format

Ex) When reading the D-Register from PV(D0001), SP(D0002)

- Transmission : [stx]01RRD,02,0001,0002[cr] [lf]

- Transmission (Include Check Sum) : [stx]01RRD,02,0001,0002E2[cr] [lf]

D0001 = 50,0, D0002 = 30,0

- Transmission : [stx]01RRD,OK,01F4,012C[cr] [lf]

- Transmission (Include Check Sum) : [stx]01RRD,OK,01F4,012C18[cr] [lf]

3.6 WSD Command

This command for writing D-Register orderly.

■ Transmission Format

Byte	1	2	3	1	2	1	4	1	4	1	...
Command element	S T X	Addr	WSD	,	Para meter Num ber	,	D-Reg.No1	,	D-Reg.No2	,	...

1	4	1	4	2	1	1
,	D-Reg.No(n-1)	,	D-Reg.No(n)	SUM	C R	L F

■ Response

Byte	1	2	3	1	2	2	1	1
Command element	S T X	Addr	WSD	,	OK	SUM	C R	L F

- Parameter number : 1 ~ 32

- dddd : Indicates a character string in hexadecimal format

Ex) When reading the D-Register from SP1(D0201), SP2(D0202)

- SP1 set : 50,0°C → Delete decimal point (500) → hexadecimal format(0x01F4)

- SP2 set : 80,0°C → Delete decimal point (800) → hexadecimal format(0x0320)

- Transmission : [stx]01WSD,02,0102,01F4,0320[cr] [lf]

- Transmission (Include Check Sum) : [stx]01WSD,02,0102,01F4,0320C4[cr] [lf]

3.7 WRD Command

This command for writing D-Register random.

■ Transmission Format

Byte	1	2	3	1	2	1	4	1	4	1	...
Command element	S	Addr	WRD	,	Parameter Number	,	D-Reg.No1	,	D-Reg.No2	,	...

1	4	1	4	2	1	1
,	D-Reg.No(n-1)	,	D-Reg.No(n)	SUM	C	L
					R	F

■ Response

Byte	1	2	3	1	2	2	1	1
Command element	S	Addr	WRD	,	OK	SUM	C	L
	T						R	F
	X							

- Parameter number : 1 ~ 32

- dddd : Indicates a character string in hexadecimal format

Ex) writing on SP1(D0201), SP4(D0204)

- SP1 set : 50,0°C → Delete decimal point (500) → hexadecimal format(0x01F4)

- SP4 set : 0,5°C → Delete decimal point (5) → hexadecimal format(0x0005)

- Transmission : [stx]01WRD,02,0201,01F4,0204,0005[cr] [lf]

- Transmission (Include Check Sum) : [stx]01WRD,02,0201,01F4,0204,0005B5[cr] [lf]

3.8 STD Command

This command is register D-register which you want to using at the SP790.

■ Transmission Format

Byte	1	2	3	1	2	1	4	1	4	1	...
Command element	S T X	Addr	STD	,	Para meter Num ber	,	D-Reg.No1	,	D-Reg.No2	,	...

1	4	1	4	2	1	1
,	D-Reg.No(n-1)	,	D-Reg.No(n)	SUM	C R	L F

■ Response

Byte	1	2	3	1	2	2	1	1
Command element	S T X	Addr	STD	,	OK	SUM	C R	L F

- Parameter number : 1 ~ 32

Ex) For Regist PW(D0001), SP(D0002)

- Transmission : [stx]01STD,02,0001,0002[cr] [lf]

- Transmission (Include Check Sum) : [stx]01STD,02,0001,0002B5[cr] [lf]

3.9 CLD Command

This command is reading D-register, which was resisted by STD Command at the SP790.

■ Transmission Format

Byte	1	2	3	2	1	1
Command element	S T X	Addr	CLD	SUM	C R	L F

■ Response

Byte	1	2	3	1	2	1	4	1	4	1	...
Command element	S T X	Addr	CLD	,	OK	,	dddd-1	,	dddd-2	,	...

1	4	1	4	2	1	1
,	dddd-(n-1)	,	dddd-(n)	SUM	C R	L F

- Parameter number : 1 ~ 32

- dddd : Indicates a character string in hexadecimal format

Ex) When the reading the D-Register that regist on STD Command

- Transmission : [stx]01CLD[cr] [lf]

- Transmission (Include Check Sum) : [stx]01CLD34[cr] [lf]

4. MODBUS Protocol

As for MODBUS communication of SP790, there are two modes of ASCII(COM.P = '3') and RTU(COM.P = '4').

① Data Format

Content	ASCII	RTU
communication start of text	:(colon)	None
communication end of text	CR+LF	None
Data Length	7-bits(fixed)	8-bits(fixed)
Data Type	ASCII	Binary
Error Detection	LRC (Longitudinal Redundancy Check)	CRC-16 (Cyclic Redundancy Check)
Data Time Interval	1sec or less	24-bits hour or less

② Constitution of Frame

- Modbus ASCII

Start of text	Address	Function Code	Data	CRC Check	End of text
1 text	2 text	2 text	N text	2 text	2 text(CR+LF)

- Modbus RTU

Start of text	Address	Function Code	Data	CRC Check	End of text
None	8-bits	8-bits	n * 8-bits	16-bits	None

4.1 Function Code

In the function code of MODBUS communication of SP790, there are a function code to read/write the contents of D-Register, and a function code to detect Loop-Back.

Function Code	Description
03	Reading D-Register orderly
06	Single D-Register Write
08	Diagnostics(Loop-Back Test)
16	Writing D-Register orderly

① Function Code – 03

Function code-03 can read up to maximum 32 contents of consecutive D-Register.

Frame Format

Content	ASCII	RTU
Start of text	:(colon)	None
Address	2 text	8-bits
Function Code-03	2 text	8-bits
D-Register Hi	2 text	8-bits
D-Register Lo	2 text	8-bits
Number to read Hi	2 text	8-bits
Number to read Lo	2 text	8-bits
Error Detection	2 text	16-bits
End of text	2 text(CR+LF)	None

Response Format

Content	ASCII	RTU
Start of text	:(colon)	None
Address	2 text	8-bits
Function Code-03	2 text	8-bits
Data Byte	2 text	8-bits
Data-1 Hi	2 text	8-bits
Data-1 Lo	2 text	8-bits
⋮	⋮	⋮
Data-n Hi	2 text	8-bits
Data-n Lo	2 text	8-bits
Error Detection	2 text	16-bits
End of text	2 text(CR+LF)	None

② Function Code – 06

Function code-06 can write to 1 contents of consecutive D-Register,

Frame Format

Content	ASCII	RTU
Start of text	:(colon)	None
Address	2 text	8-bits
Function Code-06	2 text	8-bits
D-Register Hi	2 text	8-bits
D-Register Lo	2 text	8-bits
Write Data Hi	2 text	8-bits
Write Data Lo	2 text	8-bits
Error Detection	2 text	16-bits
End of text	2 text(CR+LF)	None

Response Format

Content	ASCII	RTU
Start of text	:(colon)	None
Address	2 text	8-bits
Function Code-06	2 text	8-bits
D-Register Hi	2 text	8-bits
D-Register Lo	2 text	8-bits
Write Data Hi	2 text	8-bits
Write Data Lo	2 text	8-bits
Error Detection	2 text	16-bits
End of text	2 text(CR+LF)	None

③ Function Code – 08

Function code-08 is used self-diagnosis.

Frame Format

Content	ASCII	RTU
Start of text	:(colon)	None
Address	2 text	8-bits
Function Code-08	2 text	8-bits
Diagnosis Code Hi	2 text	8-bits
Diagnosis Code Lo	2 text	8-bits
Data Hi	2 text	8-bits
Data Lo	2 text	8-bits
Error Detection	2 text	16-bits
End of text	2 text(CR+LF)	None

Response Format

Content	ASCII	RTU
Start of text	:(colon)	None
Address	2 text	8-bits
Function Code-08	2 text	8-bits
Diagnosis Code Hi	2 text	8-bits
Diagnosis Code Lo	2 text	8-bits
Data Hi	2 text	8-bits
Data Lo	2 text	8-bits
Error Detection	2 text	16-bits
End of text	2 text(CR+LF)	None

④ Function Code – 16

Function code-16 can write to maximum 32 contents of consecutive D-Register.

Frame Format

Content	ASCII	RTU
Start of text	:(colon)	None
Address	2 text	8-bits
Function Code-16	2 text	8-bits
D-Register Hi	2 text	8-bits
D-Register Lo	2 text	8-bits
Write number Hi	2 text	8-bits
Write number Lo	2 text	8-bits
Data Byte	2 text	8-bits
Data-1 Hi	2 text	8-bits
Data-1 Lo	2 text	8-bits
⋮	⋮	⋮
Data-n Hi	2 text	8-bits
Data-n Lo	2 text	8-bits
Error Detection	2 text	16-bits
End of text	2 text(CR+LF)	None

Response Format

Content	ASCII	RTU
Start of text	:(colon)	None
Address	2 text	8-bits
Function Code-16	2 text	8-bits
D-Register Hi	2 text	8-bits
D-Register Lo	2 text	8-bits
Number of write Hi	2 text	8-bits
Number of write Lo	2 text	8-bits
Error Detection	2 text	16-bits
End of text	2 text(CR+LF)	None

5. SYNC Communication

As for SYNC communication, controller(COM.P='4') settled as master transmits RUN/STOP, SP to a controller(COM.P='5') settled as slave, and then it synchronizes operations of master and slave controller.

5.1 SYNC-Master

① SYNC-Master Model

SYNC-Master is SP790.

② Transmission Frame

SYNC,a,b,c[CR][LF]

Item	Description
a	STOP(0) / RUN(1)
b	Process value of SP (include when there is decimal points)
c	Check Sum

5.2 SYNC-Slave

① SYNC-Slave Model

The models suitable for setting as SYNC-Slave are ST590, ST580, ST570, ST560, and ST540.

② Set SYNC-Slave

To set the state of SYNC-Slave, COM.P should be settled to '5' and then fix SPSL to 'C.SP'(5).

※ There is no response for received frame(No Response).

6. BROADCAST MODE

Broadcast Mode transmits the same commands to all SP790 connected to upper Computer, and makes them to do the same works at the same time. In the mean time, lower SP790 does not send response.

To communicate via Broadcast Mode, communication command to use should be made out by making address part of communication frame as '00'.

※ It is applied only to command concerning Write among standard Commands.

※ It is applied only to 'Standard Protocol', 'Standard Protocol+Check Sum', 'MODBUS ASCII', 'MODBUS RTU' among Protocol.

7. Set Program Pattern

7.1 PROGRAM

Program group is consisted of program pattern setting D-Registers.

How to set a program pattern is :
Set one by one with changing number of segment on SP790.

※ Program pattern setting D-Register

D-Reg.	Symbol	Value	Description
D1000	P_PTNO	1~30	Set program pattern number to read or write
D1001	DEST_PTNO	1~30	Set pattern number to be copied
D1002	P_SETNO	0	Set to read or write on D1018~D1034
		1~100	Set segment to read or write
D1003	TRIGGER	1	INIT : D1000~D1004 value set '0'
		2	READ : Reading value of D1000 and D1002
		3	WRITE : Writing value of D1000 and D1002
		4	PT COPY : Copy pattern D1000 to D1001
		5	PT DEL : Delete pattern on D1000
		6	SEG INSERT : Insert segment on D1000 and D1002
		7	SEG DELETE : Delete segment on D1000 and D1002
		8	ALL PT : Display pattern of D1000 to D1500 ...
D1004	ANSWER	0	FULL : Full memory for pattern or segment
		1	DONE : Complete D1003(TRIGGER)'s job
		2	PT EMPTY : Empty pattern
		3	SEG EMPTY : Empty segment
		4	PT RUN : PROG RUN Status
		5	PARA ERROR : Setting error on D1000~D1003
		6	PT USED : PROG RUN by pattern
D1010	TEMP_TSP	-	Temp. TSP(Target Set Point) to read or write
D1011	SEG_TIME	-	Segment time to read or write
D1012	TS1	-	Time signal 1 to read or write
D1013	TS2	-	Time signal 2 to read or write
D1014	TS3	-	Time signal 3 to read or write
D1015	TS4	-	Time signal 4 to read or write
D1016	TS5	-	Time signal 5 to read or write
D1040	PID	-	PID to read or write
D1041	SEG_ALM1	-	Segment alarm 1 to read or write
D1042	SEG_ALM2	-	Segment alarm 2 to read or write
D1043	SEG_ALM3	-	Segment alarm 3 to read or write
D1044	SEG_ALM4	-	Segment alarm 4 to read or write

7.2 Reading program pattern

There is how to read program pattern on SP790

1. Set program pattern number on D1000
2. Set segment number on D1002
3. Set READ TRIGGER('2') on D1003
4. Read D1004 data and then wait until DONE('1')
5. Read data on D1010~D1016 and D1040~D1044

This list(1 ~ 5) is shown that read only one segment which in the program patterns. Therefore, if you want to read several segments you should repeat above step with change the segment number.

You can read data on D1018~D1034 when set Zero('0') at D1002 at the step 2.

7.3 Writing program pattern

There is how to write program pattern on SP790

1. Set program pattern number on D1000
2. Set segment number on D1002
3. Set data on D1010~D1016 and D1040~D1044
4. Set WRITE TRIGGER('3') on D1003
5. Read D1004 data and then wait until DONE('1')

This list(1 ~ 5) is shown that write only one segment which in the program patterns. Therefore, if you want to write several segments you should repeat above step with change the segment number.

※ You can write data on D1018~D1034 using above step.

1. Set program pattern number on D1000
2. Set '0' on D1002
3. Set READ TRIGGER('2') on D1003
4. Set program pattern number on D1000
5. Set '0' on D1002
6. Set data on D1018~D1034
7. Set WRITE TRIGGER('3') on D1003
8. Read D1004 data and then wait until DONE('1')

7.4 Pattern copy/delete & Segment insert/delete

※ Program pattern copy

1. Set object pattern number on D1000
2. Set target pattern number on D1001
3. Set PT COPY TRIGGER('4') on D1003
4. Read D1004 data and then wait until DONE('1')

※ Program pattern delete

1. Set delete pattern number on D1000
2. Set PT DEL TRIGGER('5') on D1003
3. Read D1004 data and then wait until DONE('1')

※ insert segment

1. Set program pattern number on D1000
2. Set insert pattern number on D1002
3. Set data on D1010~D1016 and D1040~D1044
4. Set SEG INSERT TRIGGER('6') on D1003
5. Read D1004 data and then wait until DONE('1')

※ Delete segment

1. Set program pattern number on D1000
2. Set delete segment number on D1002
3. Set SEG DEL TRIGGER('7') on D1003
4. Read D1004 data and then wait until DONE('1')

* D-Register 0000~0699

NO.	PROCESS	FUNCTION	SET POINT	RESERVATION	IS	ALARM	PID
	0	100	200	300	400	500	600
0		SET.PTNO	SPSL	RESERVE			
1	NPV	MODE	SP1	N.YEAR	IS1.TYPE	AL1.KIND	1.P
2	NSP		SP2	N.MONTH	IS1.HIGH	AL1.POINT	1.J
3			SP3	N.DAY	IS1.LOW	AL1.HIDEV	1.D
4		OPMODE	SP4	N.HOUR	IS1.BAND	AL1.LOWDEV	1.OH
5		PWRMODE		N.MIN	IS1.DTM	AL1.HYS	1.OL
6	MVOUT	MVOUT		RUN.YEAR		AL1.DTM	1.MR
7	HEAT.MVOUT	AM		RUN.MONTH		AL1.MODE	
8	COOL.MVOUT	FUZZY		RUN.DAY			
9	PIDNO	AT		RUN.HOUR			
10	NOWSTS	AT.ZONE		RUN.MIN			
11		FIX.OF.TIME.S	SPRH	SET.YEAR	IS2.TYPE	AL2.KIND	2.P
12	ISSTS	FIX.OF.TIME.H	SPRL	SET.MONTH	IS2.HIGH	AL2.POINT	2.J
13	TSSTS	FIX.OF.TIME.M	DISL	SET.DAY	IS2.LOW	AL2.HIDEV	2.D
14	ALSTS	UP.SLOPE	DSP.H	SET.HOUR	IS2.BAND	AL2.LOWDEV	2.OH
15		DOWN.SLOPE	DSP.L	SET.MIN	IS2.DTM	AL2.HYS	2.OL
16	DOSTS		TMU			AL2.DTM	2.MR
17		HOLD.OFF/ON				AL2.MODE	
18	DISTS	STEP.OFF/ON					
19							
20	PROC.TIME.H	WAITMD					
21	PROC.TIME.M	WZ			IS3.TYPE	AL3.KIND	3.P
22		WTM			IS3.HIGH	AL3.POINT	3.J
23	S.ALSTS				IS3.LOW	AL3.HIDEV	3.D
24					IS3.BAND	AL3.LOWDEV	3.OH
25	PTNO				IS3.DTM	AL3.HYS	3.OL
26	SEGNO					AL3.DTM	3.MR
27	R.TIME.H					AL3.MODE	
28	R.TIME.M						
29	WAIT.TIME.H						
30	WAIT.TIME.M						
31	N.LPT.RPT				IS4.KIND	AL4.TYPE	4.P
32	PT.RPT				IS4.HIGH	AL4.POINT	4.J

* D-Register 0000~0699

NO.	PROCESS	FUNCTION	SET POINT	RESERVATION	IS	ALARM	PID
	0	100	200	300	400	500	600
33	N_SEG_RPT				IS4LOW	AL4HIDEV	4D
34	SEG_RPT				IS4BAND	AL4LOWDEV	4OH
35	P_TEMP_TSP				IS4DTM	AL4HYS	4OL
36	N_TEMP_TSP					AL4DTM	4MR
37						AL4MODE	
38							
39	N_SEG_TIME						
40						S.AL1.KIND	
41						S.AL1.POINT	
42						S.AL1.HIDEV	
43						S.AL1.LOWDEV	
44						S.AL1.HYS	
45						S.AL1.DTM	
46						S.AL2.KIND	
47						S.AL2.POINT	
48						S.AL2.HIDEV	
49						S.AL2.LOWDEV	
50						S.AL2.HYS	
51						S.AL2.DTM	REF_P1
52						S.AL3.KIND	REF_P2
53						S.AL3.POINT	REF_P3
54						S.AL3.HIDEV	
55						S.AL3.LOWDEV	REF_HYS
56						S.AL3.HYS	
57						S.AL3.DTM	
58						S.AL4.KIND	
59						S.AL4.POINT	
60						S.AL4.HIDEV	
61						S.AL4.LOWDEV	1_Pc
62						S.AL4.HYS	1_Jc
63						S.AL4.DTM	1_Dc
64						S.AL5.KIND	1_OHc
65						S.AL5.POINT	1_OLc

* D-Register 0000~0699

NO.	PROCESS	FUNCTION	SET POINT	RESERVATION	IS	ALARM	PID
	0	100	200	300	400	500	600
66						S.AL5.HIDEV	1.DB
67						S.AL5.LOWDEV	
68						S.AL5.HYS	
69						S.AL5.DTM	
70						S.AL6.KIND	
71						S.AL6.POINT	2.Pc
72						S.AL6.HIDEV	2.Lc
73						S.AL6.LOWDEV	2.Dc
74						S.AL6.HYS	2.OHc
75						S.AL6.DTM	2.OLc
76						S.AL7.KIND	2.DB
77						S.AL7.POINT	
78						S.AL7.HIDEV	
79						S.AL7.LOWDEV	
80						S.AL7.HYS	
81						S.AL7.DTM	3.Pc
82						S.AL8.KIND	3.Lc
83						S.AL8.POINT	3.Dc
84						S.AL8.HIDEV	3.OHc
85						S.AL8.LOWDEV	3.OLc
86						S.AL8.HYS	3.DB
87						S.AL8.DTM	
88							
89							
90							
91							4.Pc
92							4.Lc
93							4.Dc
94							4.OHc
95							4.OLc
96							4.DB
97							
98							
99							

* D-Register 0700~1399

NO.	COMM	OUTPUT	INPUT	PROGRAM	BIAS_SET	DO_CONFIG	TS
	700	800	900	1000	1100	1200	1300
0				P_PTNO			
1	COMP	OT1SL	SEN_GROUP	DEST_PTNO	RL(P)	IS1	TS2_ONTM
2	BAUD	OT2SL	SEN_TYPE	P_SEGNO	P1(P)	IS2	TS2_OFFTM
3	PRTY	OT3SL	SEN_UNIT	TRIGGER	P2(P)	IS3	TS3_ONTM
4	SBIT	OT4SL	BIAS	ANSWER	P3(P)	IS4	TS3_OFFTM
5	DLEN	OT5SL(RELAY)	FILTER		P4(P)	TS1	TS4_ONTM
6	ADDR	SCR1_RNG_SEL			P5(P)	TS2	TS4_OFFTM
7	RP_TM	SCR2_RNG_SEL			P6(P)	TS3	TS5_ONTM
8					P7(P)	TS4	TS5_OFFTM
9					P8(P)	TS5	TS6_ONTM
10		OPR		TEMP_TSP	P9(P)	RUN	TS6_OFFTM
11		HEAT_CYCLE	RNG_HIGH	SEG_TIME	RH(P)	AL1	TS7_ONTM
12		COOL_CYCLE	RNG_LOW	TS1		AL2	TS7_OFFTM
13		ARW	DOT_POS	TS2		AL3	TS8_ONTM
14		DIRECTION	SCL_HIGH	TS3		AL4	TS8_OFFTM
15		HYS	SCL_LOW	TS4		ERR	TS9_ONTM
16		HYS(HC)		TS5		S.AL1	TS9_OFFTM
17		HEAT_PO				S.AL2	
18		COOL_PO		PT E-MODE		S.AL3	
19		HEAT_AT_GAIN		LINK_PT		S.AL4	
20		COOL_AT_GAIN		PT-REPEAT		RELAY	T1 HIGH.SP
21		RET	BO_SEL	RPT_SEG_S1		UP	T1 MID.SP
22		RETL	RJC_SEL	RPT_SEG_E1	RL(D)	UP-PARA	T1 LOW.SP
23		RETH		RPT_SEG_C1	P1(D)	SOAK	T1 HD
24				RPT_SEG_S2	P2(D)	SOAK-PARA	T1 LD
25				RPT_SEG_E2	P3(D)	DOWN	
26				RPT_SEG_C2	P4(D)	DOWN-PARA	T2 HIGH.SP
27				RPT_SEG_S3	P5(D)	PTEND	T2 MID.SP
28				RPT_SEG_E3	P6(D)	PTN-PARA	T2 LOW.SP
29				RPT_SEG_C3	P7(D)	HOLD	T2 HD
30				RPT_SEG_S4	P8(D)	HOLD-PARA	T2 LD
31				RPT_SEG_E4	P9(D)		
32				RPT_SEG_C4	RH(D)		T3 HIGH.SP

* D-Register 0700~1399

NO.	COMM	OUTPUT	INPUT	PROGRAM	BIAS_SET	DO_CONFIG	TS
	700	800	900	1000	1100	1200	1300
33				SSP			T3 MID.SP
34				STC			T3 LOW.SP
35							T31 HD
36							T3 LD
37							
38						DI3.NAME1	T4 HIGH.SP
39						DI3.NAME2	T4 MID.SP
40				PID		DI3.NAME3	T4 LOW.SP
41				S.ALM1		DI3.NAME4	T4 HD
42				S.ALM2		DI3.NAME5	T4 LD
43				S.ALM3			
44				S.ALM4		DI4.NAME1	
45						DI4.NAME2	
46						DI4.NAME3	
47						DI4.NAME4	
48						DI4.NAME5	
49							
50						T1	
51						T2	
52						T3	
53						T4	
54						T1 TM	
55						T2 TM	
56						T3 TM	
57						T4 TM	
58							
59							
60							
61							
62							
63							
64							
65							

* D-Register 0700~1399

NO.	COMM	OUTPUT	INPUT	PROGRAM	BIAS_SET	DO_CONFIG	TS
	700	800	900	1000	1100	1200	1300
66							
67							
68							
69							
70							
71							
72							
73							
74							
75							
76							
77							
78							
79							
80							
81							
82							
83							
84							
85							
86							
87							
88							
89							
90							
91							
92							
93							
94							
95							
96							
97							
98							
99							

* D-Register 1400~2099

NO.	PTTN\INFO	FILE1	FILE2	FILE3	FILE4	FILE5	FILE6
	1400	1500	1600	1700	1800	1900	2000
0	TUPT	C_TSP1	C_TM1	C_TSI1	C_TS21	C_TSS1	C_TS41
1	NPT1	C_TSP2	C_TM2	C_TSI2	C_TS22	C_TSS2	C_TS42
2	NPT2	C_TSP3	C_TM3	C_TSI3	C_TS23	C_TSS3	C_TS43
3	NPT3	C_TSP4	C_TM4	C_TSI4	C_TS24	C_TSS4	C_TS44
4	NPT4	C_TSP5	C_TM5	C_TSI5	C_TS25	C_TSS5	C_TS45
5	NPT5	C_TSP6	C_TM6	C_TSI6	C_TS26	C_TSS6	C_TS46
6	NPT6	C_TSP7	C_TM7	C_TSI7	C_TS27	C_TSS7	C_TS47
7	NPT7	C_TSP8	C_TM8	C_TSI8	C_TS28	C_TSS8	C_TS48
8	NPT8	C_TSP9	C_TM9	C_TSI9	C_TS29	C_TSS9	C_TS49
9	NPT9	C_TSP10	C_TM10	C_TSI10	C_TS210	C_TSS10	C_TS410
10	NPT10	C_TSP11	C_TM11	C_TSI11	C_TS211	C_TSS11	C_TS411
11	NPT11	C_TSP12	C_TM12	C_TSI12	C_TS212	C_TSS12	C_TS412
12	NPT12	C_TSP13	C_TM13	C_TSI13	C_TS213	C_TSS13	C_TS413
13	NPT13	C_TSP14	C_TM14	C_TSI14	C_TS214	C_TSS14	C_TS414
14	NPT14	C_TSP15	C_TM15	C_TSI15	C_TS215	C_TSS15	C_TS415
15	NPT15	C_TSP16	C_TM16	C_TSI16	C_TS216	C_TSS16	C_TS416
16	NPT16	C_TSP17	C_TM17	C_TSI17	C_TS217	C_TSS17	C_TS417
17	NPT17	C_TSP18	C_TM18	C_TSI18	C_TS218	C_TSS18	C_TS418
18	NPT18	C_TSP19	C_TM19	C_TSI19	C_TS219	C_TSS19	C_TS419
19	NPT19	C_TSP20	C_TM20	C_TSI20	C_TS220	C_TSS20	C_TS420
20	NPT20	C_TSP21	C_TM21	C_TSI21	C_TS221	C_TSS21	C_TS421
21	NPT21	C_TSP22	C_TM22	C_TSI22	C_TS222	C_TSS22	C_TS422
22	NPT22	C_TSP23	C_TM23	C_TSI23	C_TS223	C_TSS23	C_TS423
23	NPT23	C_TSP24	C_TM24	C_TSI24	C_TS224	C_TSS24	C_TS424
24	NPT24	C_TSP25	C_TM25	C_TSI25	C_TS225	C_TSS25	C_TS425
25	NPT25	C_TSP26	C_TM26	C_TSI26	C_TS226	C_TSS26	C_TS426
26	NPT26	C_TSP27	C_TM27	C_TSI27	C_TS227	C_TSS27	C_TS427
27	NPT27	C_TSP28	C_TM28	C_TSI28	C_TS228	C_TSS28	C_TS428
28	NPT28	C_TSP29	C_TM29	C_TSI29	C_TS229	C_TSS29	C_TS429
29	NPT29	C_TSP30	C_TM30	C_TSI30	C_TS230	C_TSS30	C_TS430
30	NPT30	C_TSP31	C_TM31	C_TSI31	C_TS231	C_TSS31	C_TS431
31	TUSEG	C_TSP32	C_TM32	C_TSI32	C_TS232	C_TSS32	C_TS432
32		C_TSP33	C_TM33	C_TSI33	C_TS233	C_TSS33	C_TS433

* D-Register 1400~2099

NO.	PTTN_INFO	FILE1	FILE2	FILE3	FILE4	FILE5	FILE6
	1400	1500	1600	1700	1800	1900	2000
33		C_JSP34	C_TM34	C_TSI34	C_TS234	C_TS334	C_TS434
34		C_JSP35	C_TM35	C_TSI35	C_TS235	C_TS335	C_TS435
35		C_JSP36	C_TM36	C_TSI36	C_TS236	C_TS336	C_TS436
36		C_JSP37	C_TM37	C_TSI37	C_TS237	C_TS337	C_TS437
37		C_JSP38	C_TM38	C_TSI38	C_TS238	C_TS338	C_TS438
38		C_JSP39	C_TM39	C_TSI39	C_TS239	C_TS339	C_TS439
39		C_JSP40	C_TM40	C_TSI40	C_TS240	C_TS340	C_TS440
40		C_JSP41	C_TM41	C_TSI41	C_TS241	C_TS341	C_TS441
41		C_JSP42	C_TM42	C_TSI42	C_TS242	C_TS342	C_TS442
42		C_JSP43	C_TM43	C_TSI43	C_TS243	C_TS343	C_TS443
43		C_JSP44	C_TM44	C_TSI44	C_TS244	C_TS344	C_TS444
44		C_JSP45	C_TM45	C_TSI45	C_TS245	C_TS345	C_TS445
45		C_JSP46	C_TM46	C_TSI46	C_TS246	C_TS346	C_TS446
46		C_JSP47	C_TM47	C_TSI47	C_TS247	C_TS347	C_TS447
47		C_JSP48	C_TM48	C_TSI48	C_TS248	C_TS348	C_TS448
48		C_JSP49	C_TM49	C_TSI49	C_TS249	C_TS349	C_TS449
49		C_JSP50	C_TM50	C_TSI50	C_TS250	C_TS350	C_TS450
50		C_JSP51	C_TM51	C_TSI51	C_TS251	C_TS351	C_TS451
51		C_JSP52	C_TM52	C_TSI52	C_TS252	C_TS352	C_TS452
52		C_JSP53	C_TM53	C_TSI53	C_TS253	C_TS353	C_TS453
53		C_JSP54	C_TM54	C_TSI54	C_TS254	C_TS354	C_TS454
54		C_JSP55	C_TM55	C_TSI55	C_TS255	C_TS355	C_TS455
55		C_JSP56	C_TM56	C_TSI56	C_TS256	C_TS356	C_TS456
56		C_JSP57	C_TM57	C_TSI57	C_TS257	C_TS357	C_TS457
57		C_JSP58	C_TM58	C_TSI58	C_TS258	C_TS358	C_TS458
58		C_JSP59	C_TM59	C_TSI59	C_TS259	C_TS359	C_TS459
59		C_JSP60	C_TM60	C_TSI60	C_TS260	C_TS360	C_TS460
60		C_JSP61	C_TM61	C_TSI61	C_TS261	C_TS361	C_TS461
61		C_JSP62	C_TM62	C_TSI62	C_TS262	C_TS362	C_TS462
62		C_JSP63	C_TM63	C_TSI63	C_TS263	C_TS363	C_TS463
63		C_JSP64	C_TM64	C_TSI64	C_TS264	C_TS364	C_TS464
64		C_JSP65	C_TM65	C_TSI65	C_TS265	C_TS365	C_TS465
65		C_JSP66	C_TM66	C_TSI66	C_TS266	C_TS366	C_TS466

* D-Register 1400~2099

NO.	PTTN_INFO	FILE1	FILE2	FILE3	FILE4	FILE5	FILE6
	1400	1500	1600	1700	1800	1900	2000
66		C_JSP67	C_TM67	C_TSI67	C_TS267	C_TS367	C_TS467
67		C_JSP68	C_TM68	C_TSI68	C_TS268	C_TS368	C_TS468
68		C_JSP69	C_TM69	C_TSI69	C_TS269	C_TS369	C_TS469
69		C_JSP70	C_TM70	C_TSI70	C_TS270	C_TS370	C_TS470
70		C_JSP71	C_TM71	C_TSI71	C_TS271	C_TS371	C_TS471
71		C_JSP72	C_TM72	C_TSI72	C_TS272	C_TS372	C_TS472
72		C_JSP73	C_TM73	C_TSI73	C_TS273	C_TS373	C_TS473
73		C_JSP74	C_TM74	C_TSI74	C_TS274	C_TS374	C_TS474
74		C_JSP75	C_TM75	C_TSI75	C_TS275	C_TS375	C_TS475
75		C_JSP76	C_TM76	C_TSI76	C_TS276	C_TS376	C_TS476
76		C_JSP77	C_TM77	C_TSI77	C_TS277	C_TS377	C_TS477
77		C_JSP78	C_TM78	C_TSI78	C_TS278	C_TS378	C_TS478
78		C_JSP79	C_TM79	C_TSI79	C_TS279	C_TS379	C_TS479
79		C_JSP80	C_TM80	C_TSI80	C_TS280	C_TS380	C_TS480
80		C_JSP81	C_TM81	C_TSI81	C_TS281	C_TS381	C_TS481
81		C_JSP82	C_TM82	C_TSI82	C_TS282	C_TS382	C_TS482
82		C_JSP83	C_TM83	C_TSI83	C_TS283	C_TS383	C_TS483
83		C_JSP84	C_TM84	C_TSI84	C_TS284	C_TS384	C_TS484
84		C_JSP85	C_TM85	C_TSI85	C_TS285	C_TS385	C_TS485
85		C_JSP86	C_TM86	C_TSI86	C_TS286	C_TS386	C_TS486
86		C_JSP87	C_TM87	C_TSI87	C_TS287	C_TS387	C_TS487
87		C_JSP88	C_TM88	C_TSI88	C_TS288	C_TS388	C_TS488
88		C_JSP89	C_TM89	C_TSI89	C_TS289	C_TS389	C_TS489
89		C_JSP90	C_TM90	C_TSI90	C_TS290	C_TS390	C_TS490
90		C_JSP91	C_TM91	C_TSI91	C_TS291	C_TS391	C_TS491
91		C_JSP92	C_TM92	C_TSI92	C_TS292	C_TS392	C_TS492
92		C_JSP93	C_TM93	C_TSI93	C_TS293	C_TS393	C_TS493
93		C_JSP94	C_TM94	C_TSI94	C_TS294	C_TS394	C_TS494
94		C_JSP95	C_TM95	C_TSI95	C_TS295	C_TS395	C_TS495
95		C_JSP96	C_TM96	C_TSI96	C_TS296	C_TS396	C_TS496
96		C_JSP97	C_TM97	C_TSI97	C_TS297	C_TS397	C_TS497
97		C_JSP98	C_TM98	C_TSI98	C_TS298	C_TS398	C_TS498
98		C_JSP99	C_TM99	C_TSI99	C_TS299	C_TS399	C_TS499
99		C_JSP100	C_TM100	C_TSI100	C_TS2100	C_TS3100	C_TS4100

*D-Register 2100~2799

NO.	FILE7	FILE8	FILE9	FILE10	FILE11	FILE12	RESERVED
	2100	2200	2300	2400	2500	2600	2700
0	C_TS51	C_SALM11	C_SALM21	C_SALM31	C_SALM41	C_PID1	
1	C_TS52	C_SALM12	C_SALM22	C_SALM32	C_SALM42	C_PID2	
2	C_TS53	C_SALM13	C_SALM23	C_SALM33	C_SALM43	C_PID3	
3	C_TS54	C_SALM14	C_SALM24	C_SALM34	C_SALM44	C_PID4	
4	C_TS55	C_SALM15	C_SALM25	C_SALM35	C_SALM45	C_PID5	
5	C_TS56	C_SALM16	C_SALM26	C_SALM36	C_SALM46	C_PID6	
6	C_TS57	C_SALM17	C_SALM27	C_SALM37	C_SALM47	C_PID7	
7	C_TS58	C_SALM18	C_SALM28	C_SALM38	C_SALM48	C_PID8	
8	C_TS59	C_SALM19	C_SALM29	C_SALM39	C_SALM49	C_PID9	
9	C_TS510	C_SALM110	C_SALM210	C_SALM310	C_SALM410	C_PID10	
10	C_TS511	C_SALM111	C_SALM211	C_SALM311	C_SALM411	C_PID11	
11	C_TS512	C_SALM112	C_SALM212	C_SALM312	C_SALM412	C_PID12	
12	C_TS513	C_SALM113	C_SALM213	C_SALM313	C_SALM413	C_PID13	
13	C_TS514	C_SALM114	C_SALM214	C_SALM314	C_SALM414	C_PID14	
14	C_TS515	C_SALM115	C_SALM215	C_SALM315	C_SALM415	C_PID15	
15	C_TS516	C_SALM116	C_SALM216	C_SALM316	C_SALM416	C_PID16	
16	C_TS517	C_SALM117	C_SALM217	C_SALM317	C_SALM417	C_PID17	
17	C_TS518	C_SALM118	C_SALM218	C_SALM318	C_SALM418	C_PID18	
18	C_TS519	C_SALM119	C_SALM219	C_SALM319	C_SALM419	C_PID19	
19	C_TS520	C_SALM120	C_SALM220	C_SALM320	C_SALM420	C_PID20	
20	C_TS521	C_SALM121	C_SALM221	C_SALM321	C_SALM421	C_PID21	
21	C_TS522	C_SALM122	C_SALM222	C_SALM322	C_SALM422	C_PID22	
22	C_TS523	C_SALM123	C_SALM223	C_SALM323	C_SALM423	C_PID23	
23	C_TS524	C_SALM124	C_SALM224	C_SALM324	C_SALM424	C_PID24	
24	C_TS525	C_SALM125	C_SALM225	C_SALM325	C_SALM425	C_PID25	
25	C_TS526	C_SALM126	C_SALM226	C_SALM326	C_SALM426	C_PID26	
26	C_TS527	C_SALM127	C_SALM227	C_SALM327	C_SALM427	C_PID27	
27	C_TS528	C_SALM128	C_SALM228	C_SALM328	C_SALM428	C_PID28	
28	C_TS529	C_SALM129	C_SALM229	C_SALM329	C_SALM429	C_PID29	
29	C_TS530	C_SALM130	C_SALM230	C_SALM330	C_SALM430	C_PID30	
30	C_TS531	C_SALM131	C_SALM231	C_SALM331	C_SALM431	C_PID31	
31	C_TS532	C_SALM132	C_SALM232	C_SALM332	C_SALM432	C_PID32	
32	C_TS533	C_SALM133	C_SALM233	C_SALM333	C_SALM433	C_PID33	

*D-Register 2100~2799

NO.	FILE7	FILE8	FILE9	FILE10	FILE11	FILE12	RESERVED
	2100	2200	2300	2400	2500	2600	2700
33	C_TS534	C_SALM134	C_SALM234	C_SALM334	C_SALM434	C_PID34	
34	C_TS535	C_SALM135	C_SALM235	C_SALM335	C_SALM435	C_PID35	
35	C_TS536	C_SALM136	C_SALM236	C_SALM336	C_SALM436	C_PID36	
36	C_TS537	C_SALM137	C_SALM237	C_SALM337	C_SALM437	C_PID37	
37	C_TS538	C_SALM138	C_SALM238	C_SALM338	C_SALM438	C_PID38	
38	C_TS539	C_SALM139	C_SALM239	C_SALM339	C_SALM439	C_PID39	
39	C_TS540	C_SALM140	C_SALM240	C_SALM340	C_SALM440	C_PID40	
40	C_TS541	C_SALM141	C_SALM241	C_SALM341	C_SALM441	C_PID41	
41	C_TS542	C_SALM142	C_SALM242	C_SALM342	C_SALM442	C_PID42	
42	C_TS543	C_SALM143	C_SALM243	C_SALM343	C_SALM443	C_PID43	
43	C_TS544	C_SALM144	C_SALM244	C_SALM344	C_SALM444	C_PID44	
44	C_TS545	C_SALM145	C_SALM245	C_SALM345	C_SALM445	C_PID45	
45	C_TS546	C_SALM146	C_SALM246	C_SALM346	C_SALM446	C_PID46	
46	C_TS547	C_SALM147	C_SALM247	C_SALM347	C_SALM447	C_PID47	
47	C_TS548	C_SALM148	C_SALM248	C_SALM348	C_SALM448	C_PID48	
48	C_TS549	C_SALM149	C_SALM249	C_SALM349	C_SALM449	C_PID49	
49	C_TS550	C_SALM150	C_SALM250	C_SALM350	C_SALM450	C_PID50	
50	C_TS551	C_SALM151	C_SALM251	C_SALM351	C_SALM451	C_PID51	
51	C_TS552	C_SALM152	C_SALM252	C_SALM352	C_SALM452	C_PID52	
52	C_TS553	C_SALM153	C_SALM253	C_SALM353	C_SALM453	C_PID53	
53	C_TS554	C_SALM154	C_SALM254	C_SALM354	C_SALM454	C_PID54	
54	C_TS555	C_SALM155	C_SALM255	C_SALM355	C_SALM455	C_PID55	
55	C_TS556	C_SALM156	C_SALM256	C_SALM356	C_SALM456	C_PID56	
56	C_TS557	C_SALM157	C_SALM257	C_SALM357	C_SALM457	C_PID57	
57	C_TS558	C_SALM158	C_SALM258	C_SALM358	C_SALM458	C_PID58	
58	C_TS559	C_SALM159	C_SALM259	C_SALM359	C_SALM459	C_PID59	
59	C_TS560	C_SALM160	C_SALM260	C_SALM360	C_SALM460	C_PID60	
60	C_TS561	C_SALM161	C_SALM261	C_SALM361	C_SALM461	C_PID61	
61	C_TS562	C_SALM162	C_SALM262	C_SALM362	C_SALM462	C_PID62	
62	C_TS563	C_SALM163	C_SALM263	C_SALM363	C_SALM463	C_PID63	
63	C_TS564	C_SALM164	C_SALM264	C_SALM364	C_SALM464	C_PID64	
64	C_TS565	C_SALM165	C_SALM265	C_SALM365	C_SALM465	C_PID65	
65	C_TS566	C_SALM166	C_SALM266	C_SALM366	C_SALM466	C_PID66	

* D-Register 2100~2799

NO.	FILE7	FILE8	FILE9	FILE10	FILE11	FILE12	RESERVED
	2100	2200	2300	2400	2500	2600	2700
66	C_TS567	C_S_ALM167	C_S_ALM267	C_S_ALM367	C_S_ALM467	C_PID67	
67	C_TS568	C_S_ALM168	C_S_ALM268	C_S_ALM368	C_S_ALM468	C_PID68	
68	C_TS569	C_S_ALM169	C_S_ALM269	C_S_ALM369	C_S_ALM469	C_PID69	
69	C_TS570	C_S_ALM170	C_S_ALM270	C_S_ALM370	C_S_ALM470	C_PID70	
70	C_TS571	C_S_ALM171	C_S_ALM271	C_S_ALM371	C_S_ALM471	C_PID71	
71	C_TS572	C_S_ALM172	C_S_ALM272	C_S_ALM372	C_S_ALM472	C_PID72	
72	C_TS573	C_S_ALM173	C_S_ALM273	C_S_ALM373	C_S_ALM473	C_PID73	
73	C_TS574	C_S_ALM174	C_S_ALM274	C_S_ALM374	C_S_ALM474	C_PID74	
74	C_TS575	C_S_ALM175	C_S_ALM275	C_S_ALM375	C_S_ALM475	C_PID75	
75	C_TS576	C_S_ALM176	C_S_ALM276	C_S_ALM376	C_S_ALM476	C_PID76	
76	C_TS577	C_S_ALM177	C_S_ALM277	C_S_ALM377	C_S_ALM477	C_PID77	
77	C_TS578	C_S_ALM178	C_S_ALM278	C_S_ALM378	C_S_ALM478	C_PID78	
78	C_TS579	C_S_ALM179	C_S_ALM279	C_S_ALM379	C_S_ALM479	C_PID79	
79	C_TS580	C_S_ALM180	C_S_ALM280	C_S_ALM380	C_S_ALM480	C_PID80	
80	C_TS581	C_S_ALM181	C_S_ALM281	C_S_ALM381	C_S_ALM481	C_PID81	
81	C_TS582	C_S_ALM182	C_S_ALM282	C_S_ALM382	C_S_ALM482	C_PID82	
82	C_TS583	C_S_ALM183	C_S_ALM283	C_S_ALM383	C_S_ALM483	C_PID83	
83	C_TS584	C_S_ALM184	C_S_ALM284	C_S_ALM384	C_S_ALM484	C_PID84	
84	C_TS585	C_S_ALM185	C_S_ALM285	C_S_ALM385	C_S_ALM485	C_PID85	
85	C_TS586	C_S_ALM186	C_S_ALM286	C_S_ALM386	C_S_ALM486	C_PID86	
86	C_TS587	C_S_ALM187	C_S_ALM287	C_S_ALM387	C_S_ALM487	C_PID87	
87	C_TS588	C_S_ALM188	C_S_ALM288	C_S_ALM388	C_S_ALM488	C_PID88	
88	C_TS589	C_S_ALM189	C_S_ALM289	C_S_ALM389	C_S_ALM489	C_PID89	
89	C_TS590	C_S_ALM190	C_S_ALM290	C_S_ALM390	C_S_ALM490	C_PID90	
90	C_TS591	C_S_ALM191	C_S_ALM291	C_S_ALM391	C_S_ALM491	C_PID91	
91	C_TS592	C_S_ALM192	C_S_ALM292	C_S_ALM392	C_S_ALM492	C_PID92	
92	C_TS593	C_S_ALM193	C_S_ALM293	C_S_ALM393	C_S_ALM493	C_PID93	
93	C_TS594	C_S_ALM194	C_S_ALM294	C_S_ALM394	C_S_ALM494	C_PID94	
94	C_TS595	C_S_ALM195	C_S_ALM295	C_S_ALM395	C_S_ALM495	C_PID95	
95	C_TS596	C_S_ALM196	C_S_ALM296	C_S_ALM396	C_S_ALM496	C_PID96	
96	C_TS597	C_S_ALM197	C_S_ALM297	C_S_ALM397	C_S_ALM497	C_PID97	
97	C_TS598	C_S_ALM198	C_S_ALM298	C_S_ALM398	C_S_ALM498	C_PID98	
98	C_TS599	C_S_ALM199	C_S_ALM299	C_S_ALM399	C_S_ALM499	C_PID99	
99	C_TS5100	C_S_ALM1100	C_S_ALM2100	C_S_ALM3100	C_S_ALM4100	C_PID100	

*BIT-MAP information

Bit	NOWSTS	ISSTS	TSSTS	ALSTS	ON/OFF STS
	(D0010)	(D0012)	(D0013)	(D0014)	(D0015)
0	STOP	IS1	TS1	AL1	T1
1	FIX RUN	IS2	TS2	AL2	T2
2	PROG RUN	IS3	TS3	AL3	T3
3		IS4	TS4	AL4	T4
4			TS5		
5	AT				
6	AUTO/MAN				
7					
8					
9					
10					
11					
12					
13					
14					
15					

*MODE(D0101) Operation information

Word	Operation information
1	RUN
2	HOLD
3	STEP
4	RESET
5	MAN
6	AUTO
7	FIX
8	PROG

SAMWONTECH



SAMWONTECH CO., LTD.

202-703, Buchon Techno-park,
Yakdae-dong, Wonmi-gu, Buchon,
Gyeonggi-do, Korea 420-733
TEL: +82-32-326-9120, 9121
FAX: +82-32-326-9119
[http:// www.samwontech.com](http://www.samwontech.com)
E-mail: webmaster@samwontech.com

Further information contact Samwontech